



LabVIEW™

QuickStart Guide

Conventions Used in This Manual

The following conventions are used in this manual:

- bold** Bold text denotes a menu name, palette name, menu item, or dialog box button or option.
Bold text also denotes a tip.
- bold italic*** Bold italic text denotes a note.
- italic* Italic text denotes a variable, glossary term, or cross reference.
- monospace Text in this font denotes text or characters that you should type. This font also is used for the proper names of disk drives, paths, directories, programs, filenames, and extensions.

Copyright

Under the copyright laws, this publication may not be reproduced or transmitted in any form, electronic or mechanical, including photocopying, recording, storing in an information retrieval system, or translating, in whole or in part, without the prior written consent of National Instruments Corporation.

Trademarks

LabVIEW™, natinst.com™, NI-DAQ™, and PXI™ are trademarks of National Instruments Corporation. Product and company names listed are trademarks or trade names of their respective companies.

Internet Support

E-mail: support@natinst.com

FTP Site: <ftp.natinst.com>

Web Address: <http://www.natinst.com>

Bulletin Board Support

BBS United States: 512 794 5422

BBS United Kingdom: 01635 551422

BBS France: 01 48 65 15 59

Fax-on-Demand Support

512 418 1111

Telephone Support (USA)

Tel: 512 795 8248

Fax: 512 794 5678

International Offices

Australia 03 9879 5166, Austria 0662 45 79 90 0, Belgium 02 757 00 20, Brazil 011 288 3336, Canada (Ontario) 905 785 0085, Canada (Québec) 514 694 8521, Denmark 45 76 26 00, Finland 09 725 725 11, France 01 48 14 24 24, Germany 089 741 31 30, Hong Kong 2645 3186, Israel 03 6120092, Italy 02 413091, Japan 03 5472 2970, Korea 02 596 7456, Mexico 5 520 2635, Netherlands 0348 433466, Norway 32 84 84 00, Singapore 2265886, Spain 91 640 0085, Sweden 08 730 49 70, Switzerland 056 200 51 51, Taiwan 02 377 1200, United Kingdom 01635 523545

National Instruments Corporate Headquarters

6504 Bridge Point Parkway Austin, Texas 78730-5039 USA Tel: 512 794 0100

Contents

Chapter 1

Introduction to LabVIEW

What Is LabVIEW?	1-1
Why Should I Use LabVIEW?	1-3
How Does LabVIEW Work?	1-4
Front Panel.....	1-4
Block Diagram.....	1-5
Palettes.....	1-6
Tools Palette.....	1-6
Controls Palette	1-6
Functions Palette	1-7
Data Flow	1-7
Where Do I Start?	1-8
Online Tutorial	1-8

Chapter 2

Virtual Instruments

Search for Examples	2-1
Build a Virtual Instrument	2-4
Create a User Interface	2-4
Build the Block Diagram.....	2-8
Wire and Run Your VI	2-10
Add Timing to Your VI.....	2-12
Add Analysis and File I/O to Your VI	2-14

Chapter 3

Data Acquisition

Use the DAQ Solution Wizard	3-1
Configure Your Analog Input Channel	3-2
Generate a Solution from the Solutions Gallery.....	3-12
Add Analog Input to Your VI.....	3-17

Chapter 4

Instrumentation

Instrument I/O.....	4-1
Use the Instrument Wizard	4-2
Run the Demo Scope VI.....	4-9

Chapter 5 Debugging

Use Execution Highlighting	5-1
Single-Step with Probes	5-3

Chapter 6 Where to Go from Here

Online Help	6-1
Show Help.....	6-2
National Instruments' Commitment to You	6-3
Customer Education	6-3
Alliance Program	6-3
Technical Support	6-3

Appendix A System Requirements

Windows.....	A-1
Macintosh	A-1
UNIX	A-2

Glossary

Introduction to LabVIEW

This chapter provides an overview of the LabVIEW development environment.

For information about system configuration requirements, see Appendix A, *System Requirements*. Refer to the *LabVIEW 5.1 Addendum* for installation instructions.

What Is LabVIEW?

Italicized text denotes a glossary term.

LabVIEW (Laboratory Virtual Instrument Engineering Workbench) is a development environment based on the graphical programming language *G*. LabVIEW is integrated fully for communication with hardware such as *GPIB*, *VXI*, *PXI*, *RS-232*, *RS-485*, and plug-in data acquisition boards. LabVIEW also has built-in libraries for using software standards such as TCP/IP Networking and ActiveX.

Using LabVIEW, you can create 32-bit compiled programs that give you the fast execution speeds needed for custom data acquisition, test, and measurement solutions. You also can create stand-alone executables because LabVIEW is a true 32-bit compiler.

You can use LabVIEW with little programming experience. LabVIEW uses terminology, icons, and ideas familiar to technicians, scientists, and engineers, and relies on graphical symbols rather than textual language to describe programming actions.

Programs in LabVIEW for real-world applications can vary from the simple to the powerful, as illustrated in the following graphic.

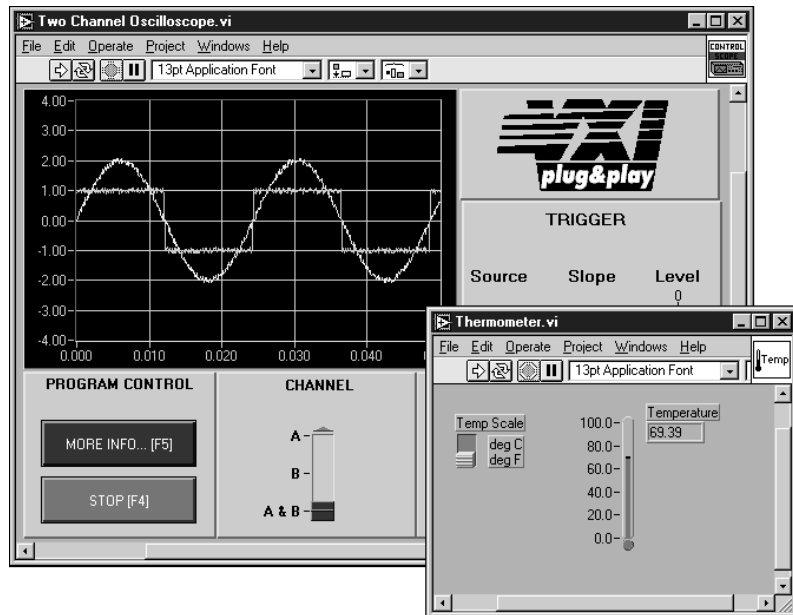

LabVIEW contains comprehensive libraries for data collection, analysis, presentation, and storage. LabVIEW also includes traditional program development tools. You can set breakpoints, animate program execution to see how the program executes, and single-step through the program to make debugging and program development easier.

LabVIEW also provides numerous mechanisms for connecting to external code or software through DLLs, shared libraries, ActiveX, and more. In addition, numerous add-on toolkits are available for a variety of application needs.

Why Should I Use LabVIEW?

LabVIEW empowers you to build your own solutions for scientific and engineering systems. LabVIEW gives you the flexibility and performance of a powerful programming language without the associated difficulty and complexity.

LabVIEW has given thousands of successful users a faster way to program instrumentation and data acquisition systems. By using LabVIEW to

prototype, design, test, and implement your instrument systems, you can reduce system development time and increase productivity by a factor of 4 to 10.

LabVIEW also gives you the benefits of a large installed user base, years of product feedback, and powerful add-on tools. Finally, the National Instruments user network and technical support ensure the successful development of your solutions.

How Does LabVIEW Work?

All LabVIEW programs, or *virtual instruments* (VIs), have a *front panel* and a *block diagram*. The *palettes* in LabVIEW contain the options you use to create and modify your VI. This section overviews the LabVIEW front panel, block diagram, and palettes. It also explains the *dataflow* model for program execution that LabVIEW follows.

Front Panel

The front panel is the graphical user interface of your LabVIEW VI. This interface collects user input and displays program output. The front panel can contain knobs, push buttons, graphs, and other *controls* and *indicators*.

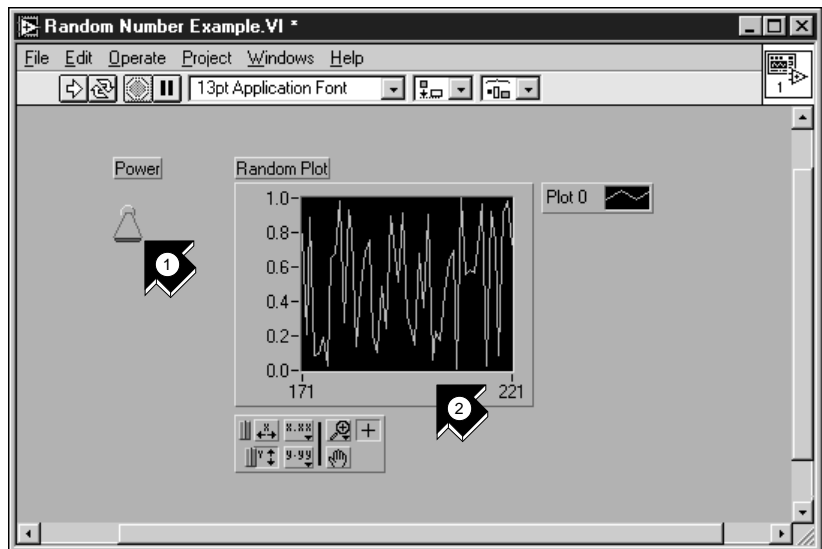

1. A control (input).
2. An indicator (output).

Block Diagram

The block diagram contains the graphical source code of your VI. In the block diagram, you program your VI to control and perform functions on the inputs and outputs you created on the front panel.

The block diagram can include *functions* and *structures* from the built-in LabVIEW VI libraries. It also can include *terminals* that are associated with controls and indicators created on the front panel.

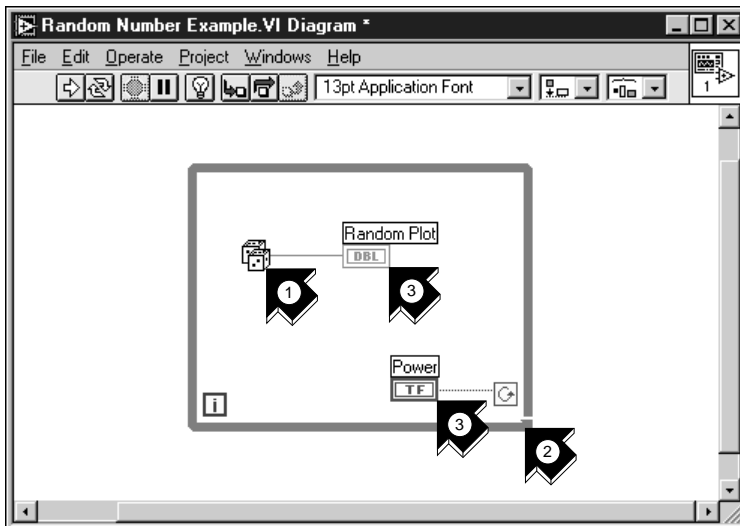

1. A function.
2. A structure.
3. Terminals from the front panel.

Palettes

LabVIEW *palettes* give you the options you need to create and edit your front panel and block diagram.

Tools Palette

You use the *Tools palette* in both the front panel and the block diagram. The Tools palette contains the tools you use to edit and debug front panel and block diagram objects.



Controls Palette

You use the *Controls palette* in the front panel. The Controls palette contains the front panel controls and indicators you use to create the user interface.



Functions Palette

You use the *Functions palette* in the block diagram. The Functions palette contains the objects you use to program your VI, such as arithmetic, instrument I/O, file I/O, and data acquisition operations.



Data Flow

LabVIEW VIs follow a dataflow model for program execution. The block diagram consists of *nodes* such as VIs, structures, and terminals from the front panel. These nodes are connected by *wires*, which define the flow of data through the program. The execution of a node occurs when all its inputs are available. When a node finishes executing, it releases all its outputs to the next node in the dataflow path.

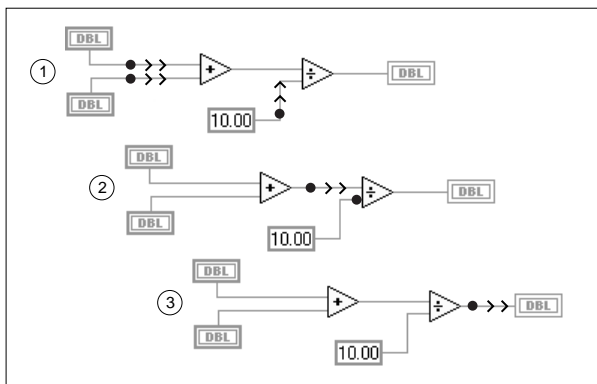

Where Do I Start?

If you are new to LabVIEW, the *LabVIEW Online Tutorial* and the *LabVIEW QuickStart Guide* help you get started quickly. The *LabVIEW Online Tutorial* introduces you to the LabVIEW environment. The *LabVIEW QuickStart Guide* teaches you to build VIs for data acquisition and instrument control and how to debug these VIs. It also teaches you how to use the Search Examples feature and the DAQ Solution Wizard.



You can complete the activities in this book in approximately 90 minutes.



Note *The LabVIEW Online Tutorial and the Search Examples feature currently are available on Windows platforms only.*

Online Tutorial

To learn about the LabVIEW environment, first launch the *LabVIEW Online Tutorial* from the LabVIEW dialog box.



You can complete the online tutorial in approximately 15 minutes.

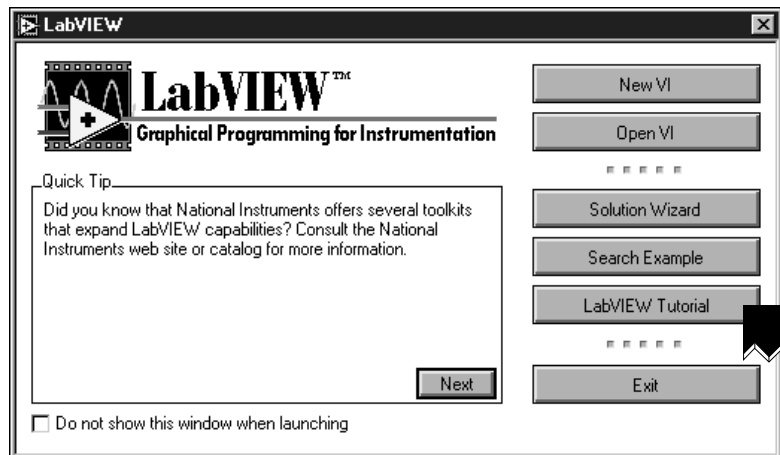

After you finish the *LabVIEW Online Tutorial*, continue with the activities in the *LabVIEW QuickStart Guide* to learn how to build LabVIEW programs for data acquisition and instrument control.

You should complete the activities in this book in the order in which they appear because subsequent activities build upon the sample programs you create. Approximate completion times are given for each activity and each section within an activity.

Virtual Instruments

This chapter teaches you step-by-step how to create an application in LabVIEW. It also guides you through the Search Examples feature to help you find examples in LabVIEW.



Note *The Search Examples feature currently is available on Windows only.*

You will learn to do the following:

- Use the Search Examples feature to find and run an example.
- Create a new program in LabVIEW. The VI you build generates data, analyzes it, then writes it to a file.

Search for Examples

After viewing the *LabVIEW Online Tutorial*, you are ready to run some examples in LabVIEW.



You can complete this activity in approximately 5 minutes.

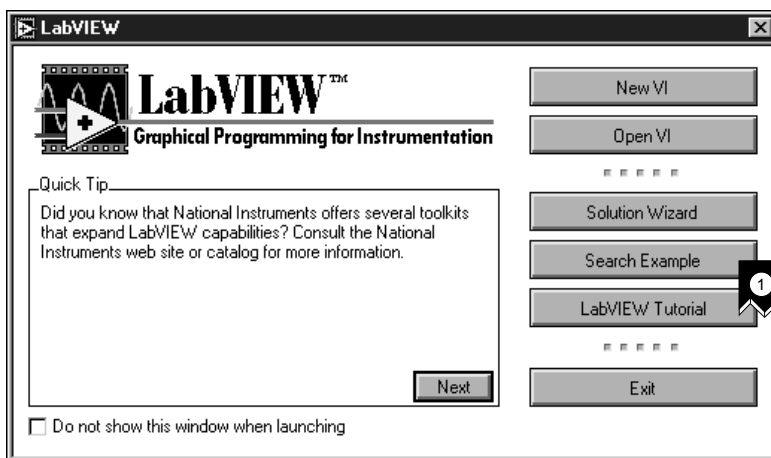

1. Click **Search Example** to see a listing of LabVIEW examples.

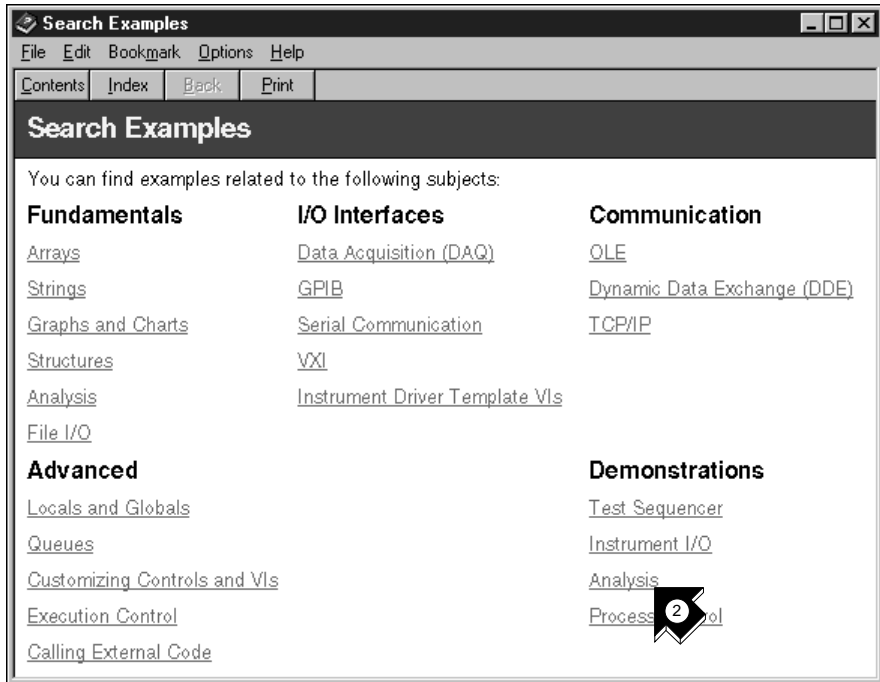

2. Click **Analysis** in the Demonstrations category.

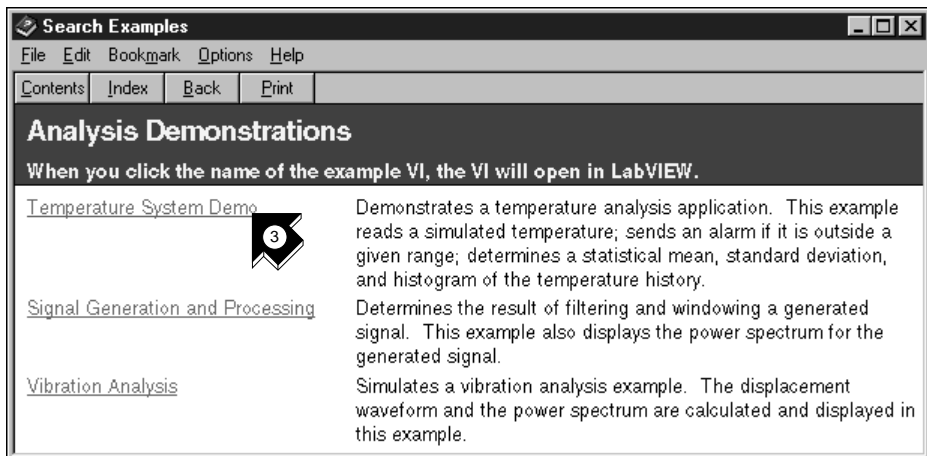

3. Click **Temperature System Demo** to open this demonstration VI.

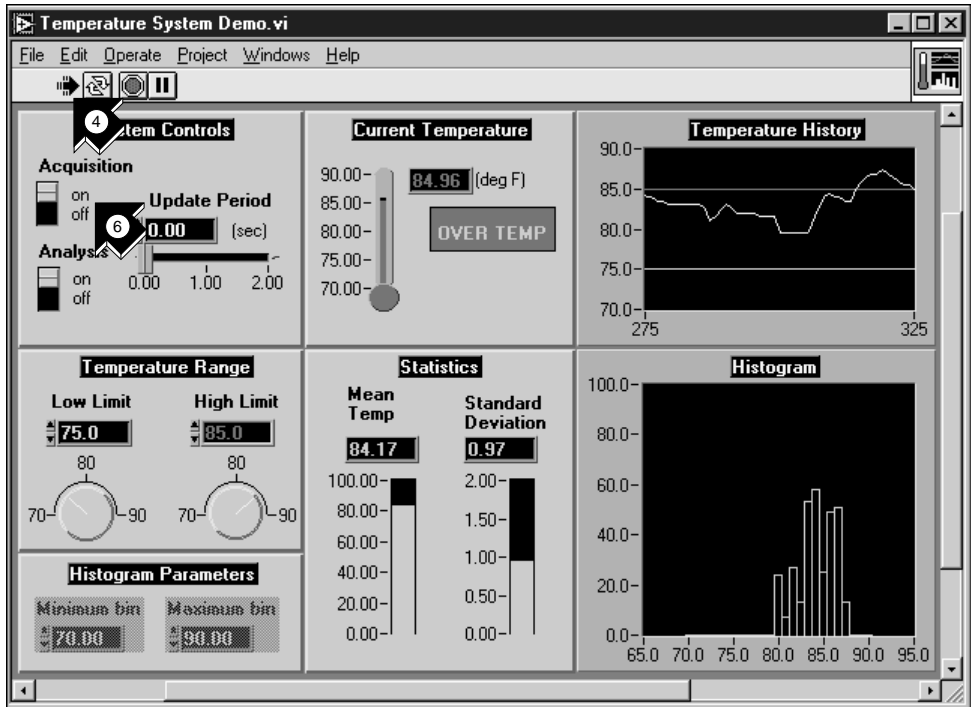

Run

4. Click the **Run** button on the front panel toolbar to see how a LabVIEW VI runs.
5. Click the sliders, knobs, and other controls to see how they affect the data.
6. Stop the program by clicking the **Acquisition** switch to the **off** position.

Build a Virtual Instrument

This activity demonstrates how easily you can chart, analyze, and save data in LabVIEW.



You can complete this activity in approximately 30 minutes.

Create a User Interface

You can create a graphical user interface on the front panel using controls and indicators from the Controls palette.



You can complete this section in approximately 5 minutes.

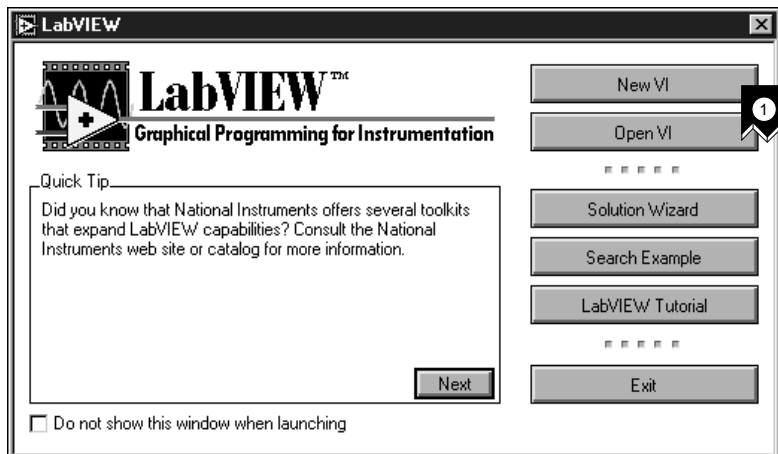

1. Create a new VI by selecting **New VI** in the LabVIEW dialog box.

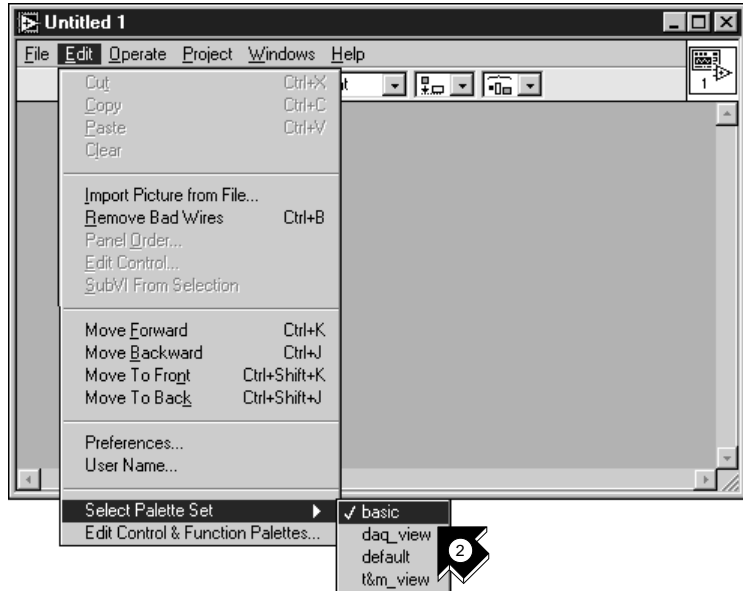

2. On the new front panel, choose **Edit»Select Palette Set»basic**.



Tips The » symbol leads you through nested menu and palette items to a final action. The sequence **Edit»Select Palette Set»basic** directs you to open the Edit menu, click Select Palette Set, and finally choose basic as your palette.

The basic palette set you select for this activity is a small subset of the LabVIEW libraries. You can select the default palette set to view the entire functionality of LabVIEW.

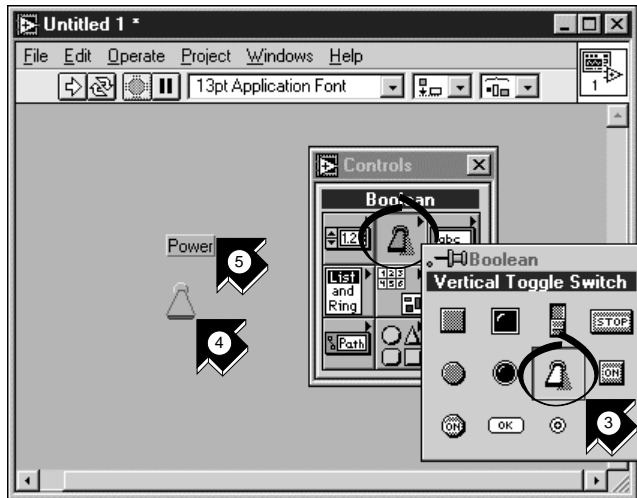

3. Select **Vertical Toggle Switch** from the **Controls»Boolean subpalette**. Select icons from the palette in the same way you select items from a menu.
4. Move your pointer into the front panel and click to place the toggle switch on the front panel.
5. Type **Power** into the label for the toggle switch. If the label disappears, choose **Show Label** from the pop-up menu on the toggle switch. To access the pop-up menu, right-click the toggle switch (on the Macintosh, command-click the toggle switch).



Tip To rearrange or resize objects and wires, use the *Positioning tool* from the **Tools palette**.



Positioning tool

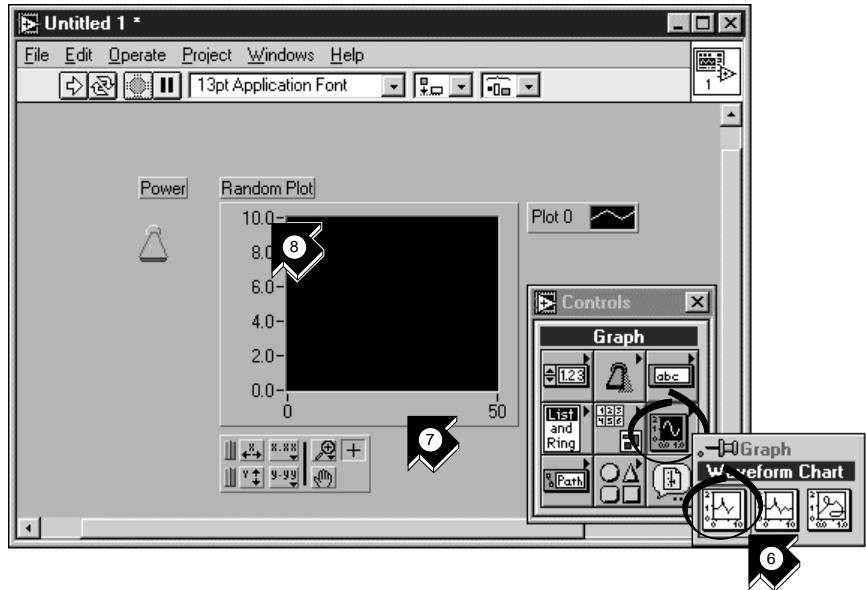

6. Create a *waveform chart* by selecting **Controls»Graph»Waveform Chart**. This chart plots data one point at a time.
7. Place the chart on the front panel and label it **Random Plot**.
8. To change the scale of the waveform chart, select the *Operating tool* from the Tools palette. If the Tools palette is not visible, select **Windows»Show Tools Palette**. Double-click **10.0** on the Y axis of the **Random Plot** indicator and type **1.0** to change the scale.



Operating tool

Build the Block Diagram

Now you can create the source code in the block diagram of your VI.



You can complete this section in approximately 5 minutes.

1. Go to the block diagram by choosing **Show Diagram** from the **Windows** menu or clicking in the block diagram window. The two terminals on the block diagram correspond to the Power toggle switch and the Random Plot waveform chart on the front panel.

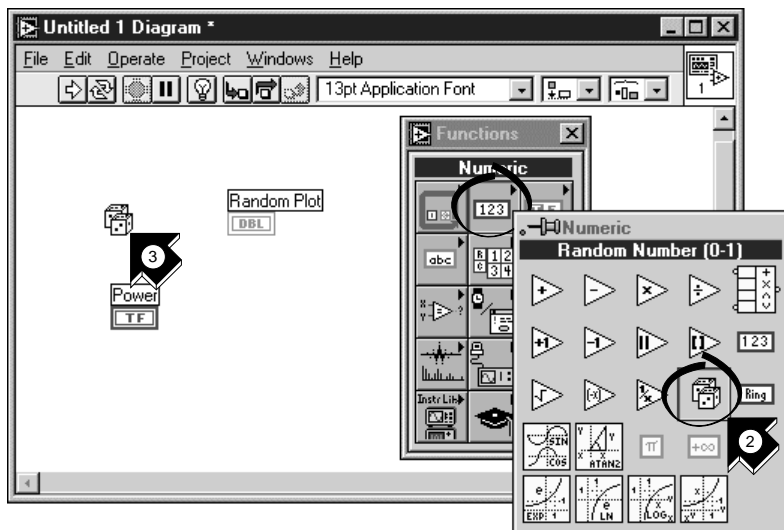

2. Select **Random Number (0–1)** from the **Functions»Numeric** subpalette. If the Functions palette is not visible, select **Windows»Show Functions Palette**. For this activity, you use a random number generator to generate input data for your VI.
3. Place the Random Number function on the block diagram. This VI generates a random number ranging from zero to one.

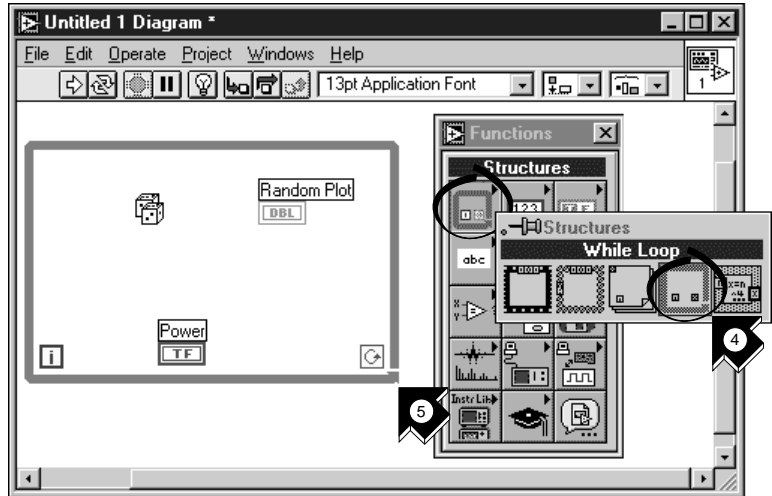

conditional terminal

4. Select **While Loop** from the **Functions»Structures** subpalette. The *While Loop* runs all code within its boundaries while the value on its *conditional terminal* remains TRUE. When the value changes to FALSE, the While Loop exits.
5. Place your pointer in the position on the block diagram where you want to anchor the top-left corner of the loop. Drag the loop diagonally to enclose the Random Number function, the Power toggle switch, and the Random Plot chart.



Tip If your While Loop does not enclose all of the code, right-click in the border of the loop to access the pop-up menu (on the Macintosh, command-click in the border of the loop). Choose Remove While Loop from this pop-up menu. Then repeat steps four and five to re-create the loop so it encloses all the code.

Wire and Run Your VI

You need to add wiring to define the data flow in your VI. After your VI is complete, you can run it from the front panel to see the data plot to your chart.



You can complete this section in approximately 5 minutes.



Wiring tool

1. Select the *Wiring tool* from the Tools palette. If the Tools palette is not visible, select **Windows»Show Tools Palette**.

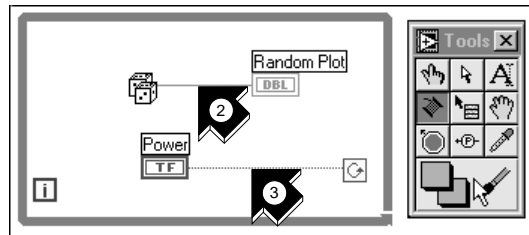

2. Wire the Random Number function to the Random Plot chart terminal. To create a wire, click the Random Number function, move your pointer to the Random Plot chart, and click again to terminate the wire.



Tips When you position the Wiring tool over a terminal, the terminal blinks and a *tip strip* appears that labels the terminal. When the correct terminal blinks, click to wire to or from that terminal.

If you see black dashed wires, select **Edit»Remove Bad Wires**.



conditional terminal

3. Wire the Power toggle switch terminal to the conditional terminal on the While Loop.

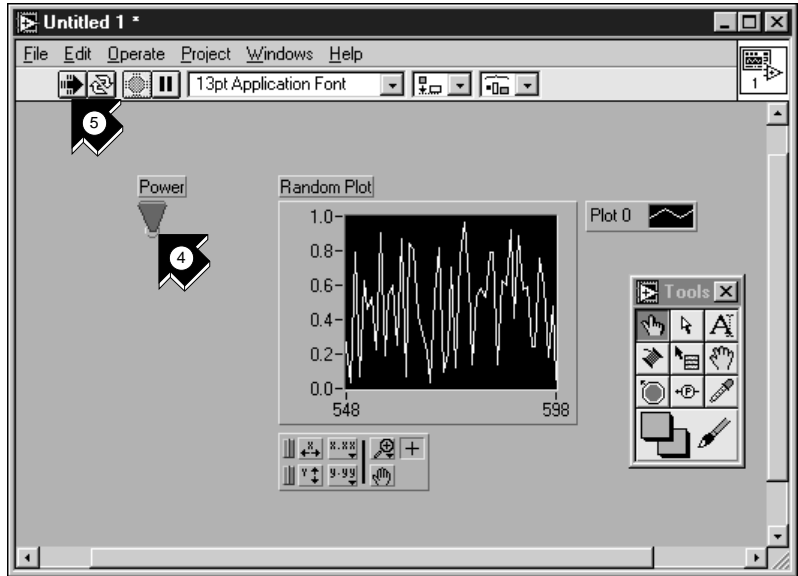

Operating tool



Run

4. Go to the front panel and select the **Operating** tool. Click the Power toggle switch to the TRUE position.
5. Click the **Run** button on the toolbar to run the VI.
6. To stop the VI, click the Power toggle switch to the FALSE position. Because the While Loop executes only as long as its conditional terminal remains TRUE, changing the value of the toggle switch to FALSE stops the loop.

Add Timing to Your VI

You can add a timing delay to your VI to plot the points more slowly on the waveform chart.



You can complete this section in approximately 5 minutes.

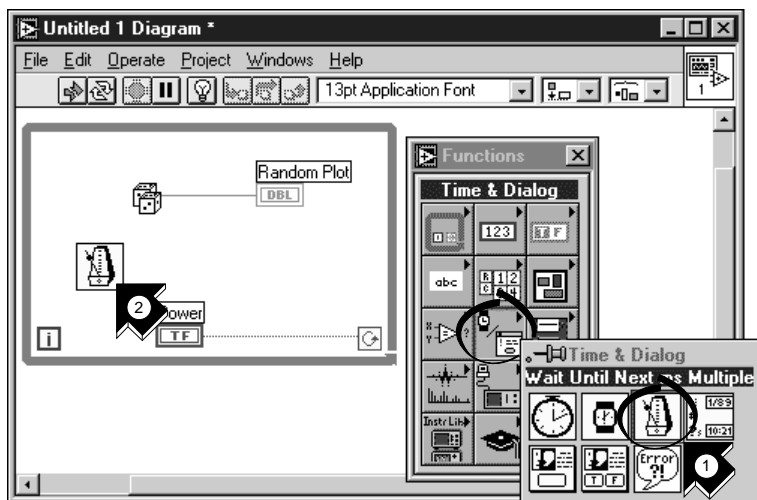

1. Go to the block diagram. Select **Wait Until Next ms Multiple** from the **Functions»Time & Dialog** subpalette.
2. Place the Wait Until Next ms Multiple function within the While Loop.

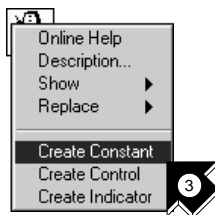

3. From the pop-up menu on the left side of the Wait Until Next ms Multiple function, choose **Create Constant**. When you access the pop-up menu of the function, make sure you position the pointer over the left side of the function. Otherwise, the constant you create is not wired to the function.



Tip To access the pop-up menu of a LabVIEW object, right-click the object. On the Macintosh, command-click the object.

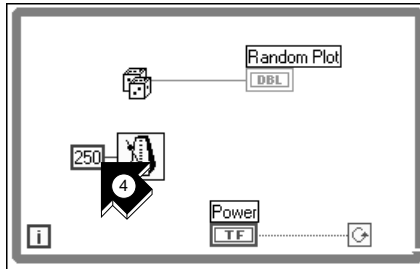

4. Type 250 in the millisecond multiple control to create a 250 ms delay between the generation of points to plot for the chart.
5. Go to the front panel, click the Power toggle switch to the TRUE position, and run the VI to see the delay effect. Click the Power toggle switch to the FALSE position to stop the VI. Save this program as `Random Number Example.vi` in the `LabVIEW\vi.lib\tutorial.llb` directory.



Run

**Note**

Paths in this manual are denoted using backslashes (\) to separate drive names, directories, and files.

Add Analysis and File I/O to Your VI

You can average the random data points you have collected and save your data to a spreadsheet file.



You can complete this section in approximately 10 minutes.

1. Go to the block diagram window of the Random Number Example VI you have created. If your VI is not open already, choose Random Number Example.vi from the LabVIEW\vi.lib\tutorial.lib directory.

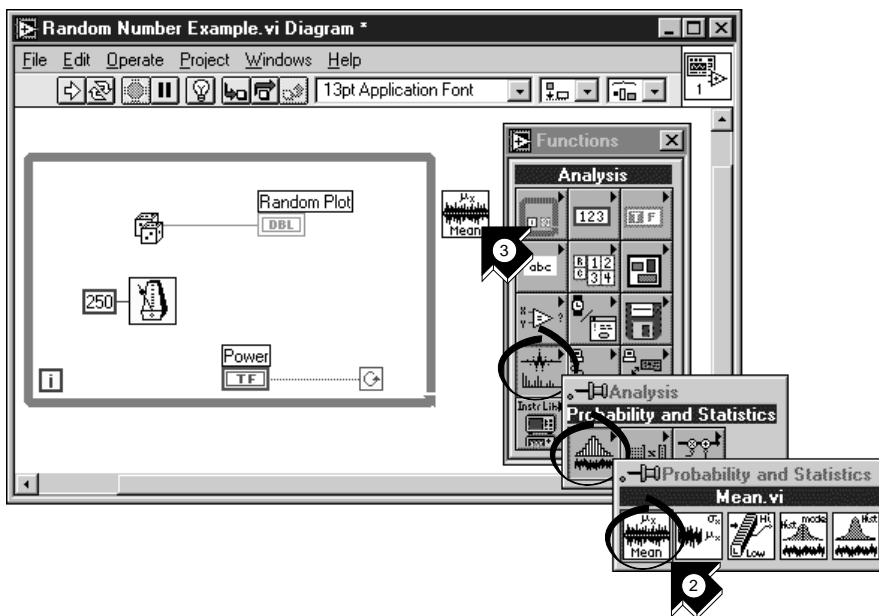

2. Select **Mean.vi** from the **Functions»Analysis»Probability and Statistics** subpalette.



Tip If you do not see the **Functions palette**, select **Windows»Show Functions Palette**.

3. Place the Mean VI in the block diagram outside the While Loop.

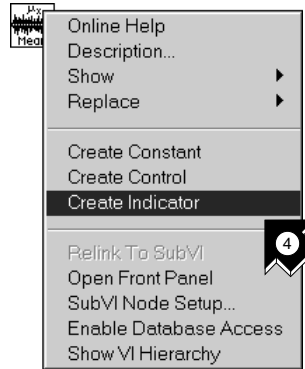

- From the pop-up menu on the upper-right corner of the Mean VI, choose **Create Indicator**. This creates a front panel numeric indicator to display the mean of the random data.

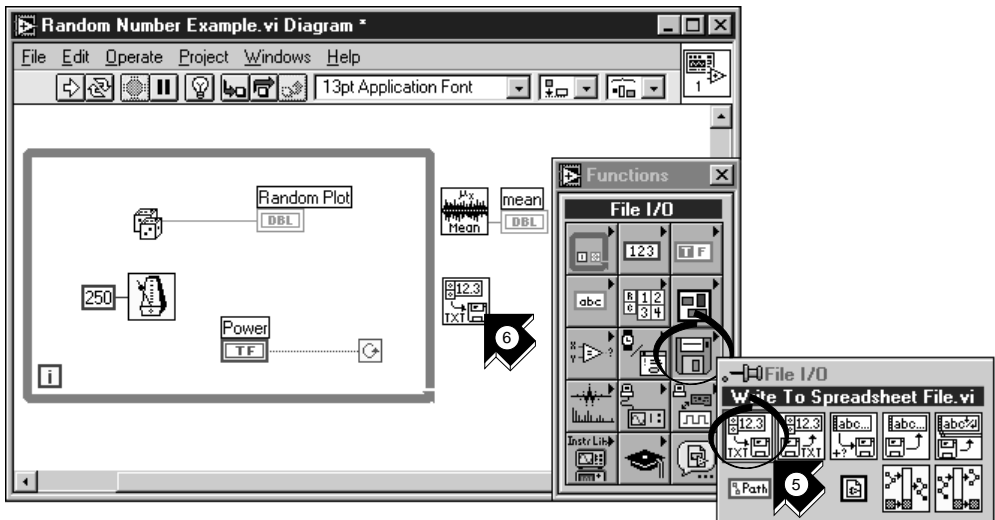

- Select **Write To Spreadsheet File.vi** from the **Functions»File I/O** subpalette.
- Place the Write To Spreadsheet File VI in the block diagram outside the While Loop.

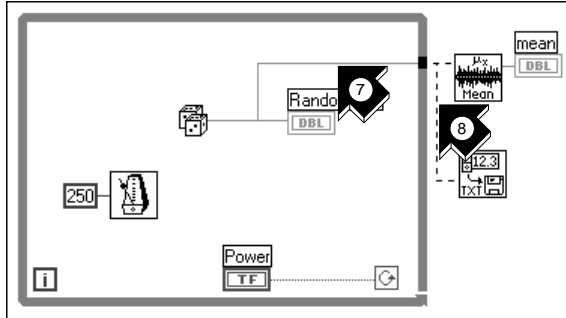

- Using the **Wiring** tool, wire the Random Number function to the **X** input terminal of the Mean VI. Create this *wire branch* by wiring from the existing *wire segment*.



Tips

The wire segment blinks when the Wiring tool is positioned correctly to fasten a new wire from the existing segment.

The Wiring tool enables you to see tip-strip labels for terminals on nodes in the block diagram.

- Create another wire branch from the branch created in the previous step. Wire this new branch to the **1D data** input of the Write to Spreadsheet File VI. You use the 1D data input because the While Loop creates a one-dimensional row of data from the generated random numbers.

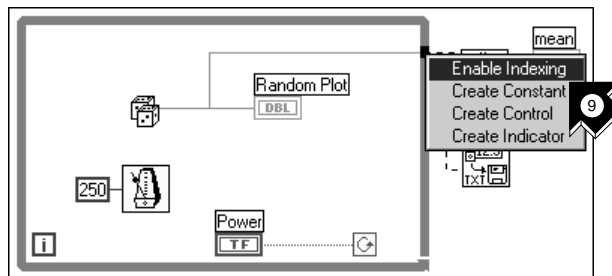

- The black *tunnel* on the While Loop is a data exit terminal on the loop. From the pop-up menu on the black tunnel, choose **Enable Indexing**. The dashed wires change to solid orange wires. *Enable Indexing* allows the While Loop to collect the data and pass it to the Mean VI as a data set when the loop terminates.



10. Go to the front panel. Using the **Operating** tool, click the Power toggle switch to the TRUE position and run the VI.

Operating tool

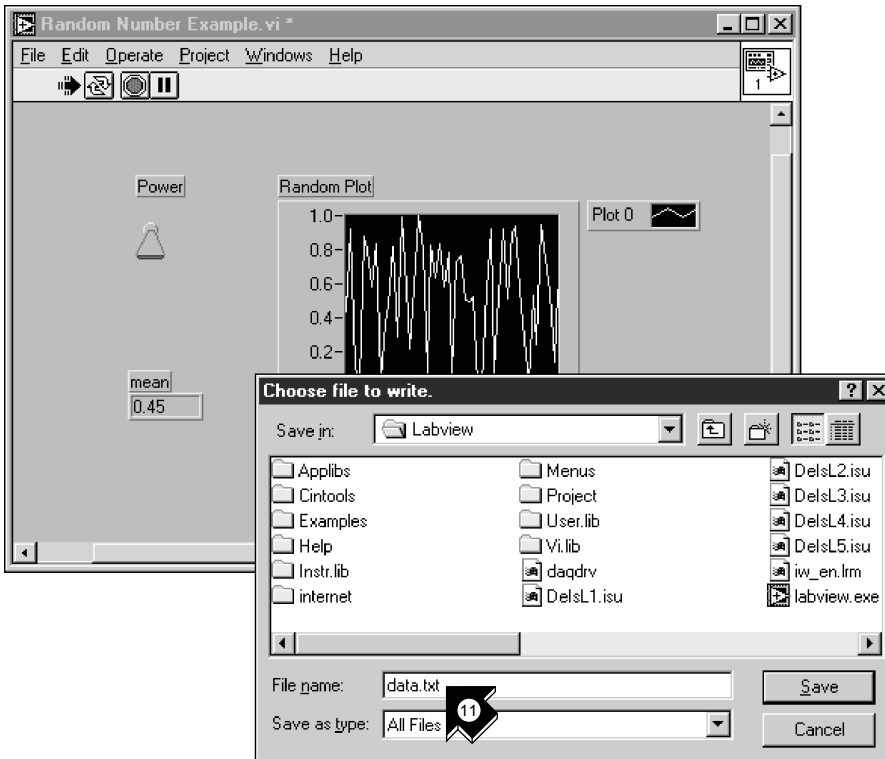

11. When you turn off the power, you see the mean of your data and a file dialog box that prompts you for the name of the random number file. Type `data.txt` and click **Save**.



Tip The mean does not appear until the data is collected when you click the Power toggle switch to the FALSE position.

12. Use any text editor to open `data.txt` and view the data.



Note

You can find the solution to this activity in `LabVIEW\vi.lib\tutorial.11b\Random Number Example Solution.vi`.

Data Acquisition

This chapter teaches you how to use LabVIEW with data acquisition (DAQ) hardware. If you only use stand-alone instruments and control them with GPIB, VXI, or serial standards, see Chapter 4, *Instrumentation*.

**Note**

Data acquisition is supported on Windows and Macintosh only. The DAQ wizards are available on Windows and Power Macintosh only.

You will learn to do the following:

- Use the *DAQ Solution Wizard* to generate solutions for data acquisition applications.
 - Use the *DAQ Channel Wizard* to configure your analog input channel.
 - Generate a solution from the *Solutions Gallery*.
- Add analog input to the VI you created in Chapter 2, *Virtual Instruments*.

**Note**

Refer to your hardware manual or the NI-DAQ Help file for data acquisition hardware installation and configuration instructions.

Use the DAQ Solution Wizard

If you are using DAQ hardware, you must configure your analog input channels. You can launch the DAQ Channel Wizard from the DAQ Solution Wizard to configure your channels. Then you can generate a DAQ solution from the Solutions Gallery.



You can complete this activity in approximately 15 minutes.

Configure Your Analog Input Channel

The DAQ Solution Wizard guides you through naming and configuring your analog and digital channels using the DAQ Channel Wizard.



You can complete this section in approximately 5 minutes.

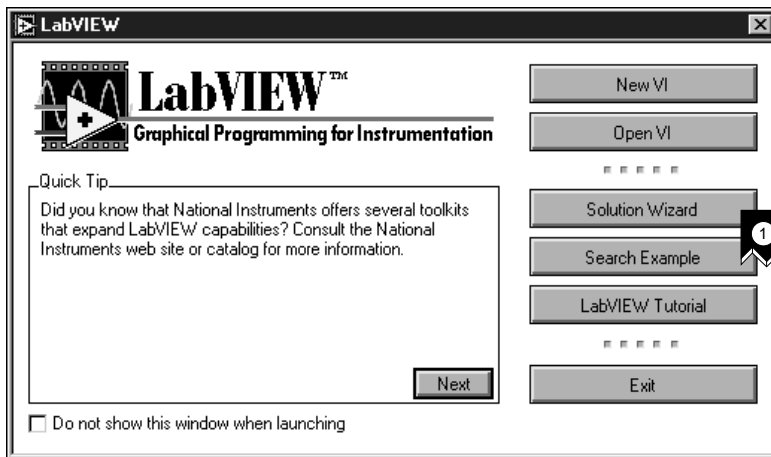

1. To get started with analog input quickly and easily, select **Solution Wizard** in the LabVIEW dialog box. When prompted, select **DAQ Solution Wizard** and click **Launch Wizard...** to begin.



Tip To access the LabVIEW dialog box, either launch LabVIEW or close all open VIs if you already are running LabVIEW.

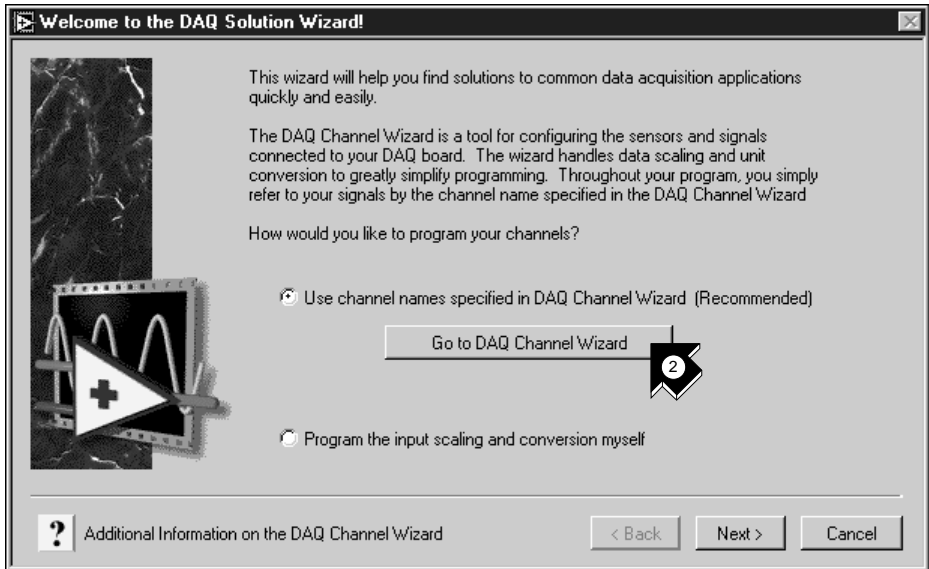

2. When the Welcome to the DAQ Solution Wizard! dialog box opens, click **Go to DAQ Channel Wizard**.

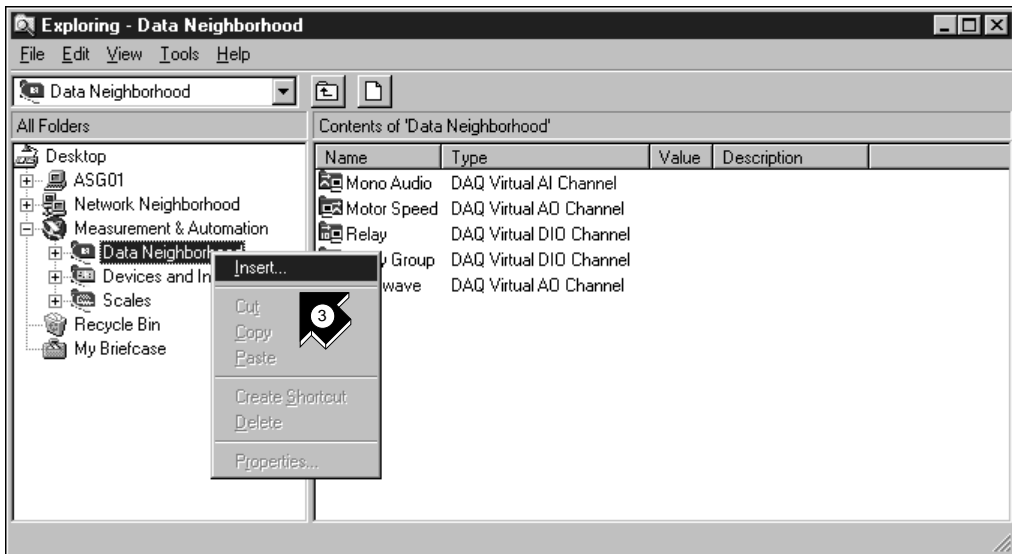

3. Select the Data Neighborhood view in Measurement & Automation Explorer. Right click on Data Neighborhood and select **Insert...** to configure a new channel. Click **OK** in the Insert New dialog box.

The DAQ Channel Wizard helps you configure analog and digital channels by name so you can use those names in your program. The DAQ Channel Wizard also conditions those channels so signal conditioning such as scaling factors and cold-junction compensation are performed transparently to you.

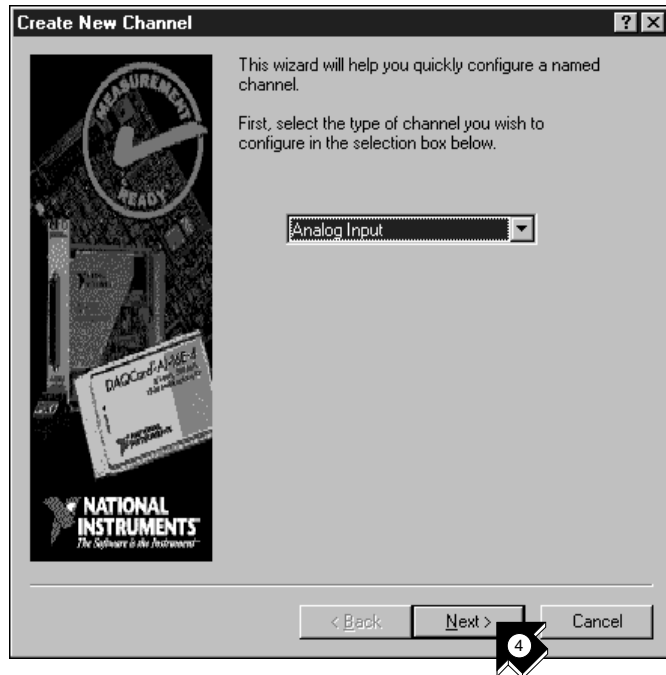

4. Select **Analog Input** as the channel type to configure and click **Next >**. You also can configure analog output and digital input/output in the DAQ Channel Wizard.

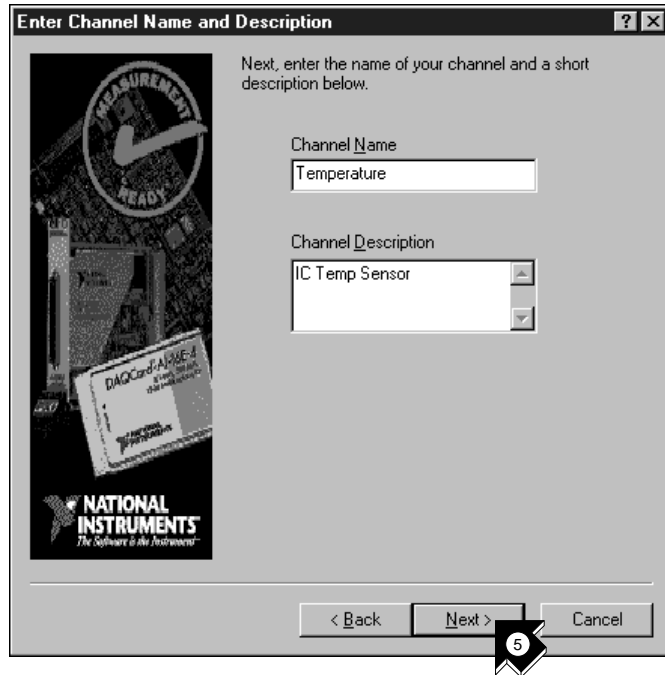

5. Type your channel name and description in the appropriate text boxes. Click **Next>** to continue.

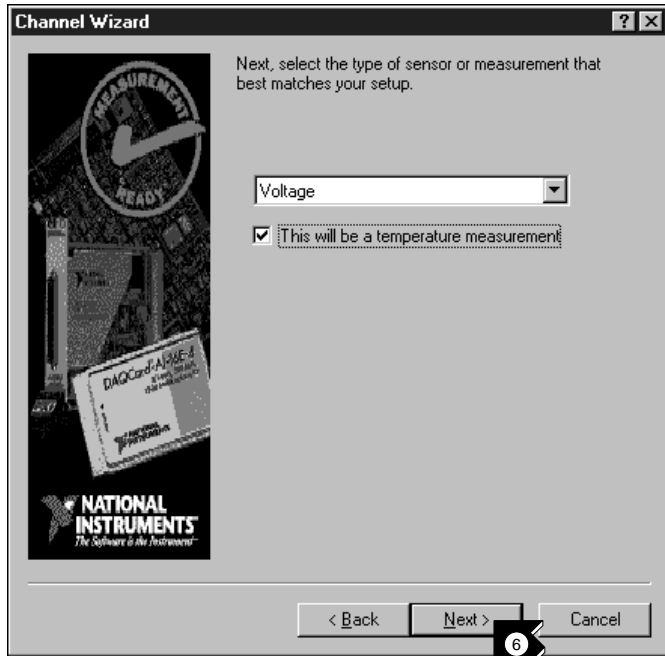

6. You can select the type of sensor in the drop-down list box. Select the check box to mark the channel as a temperature measurement. Click **Next>** to continue.



Tip If you are not taking a temperature reading, use parameters in the DAQ Channel Wizard appropriate for your measurement.



7. Define the physical quantity that you are measuring. Select the units and enter the range in the appropriate boxes. Click **Next>** to continue.



8. Define the scaling and range of the sensor. Click **Next**> to continue.

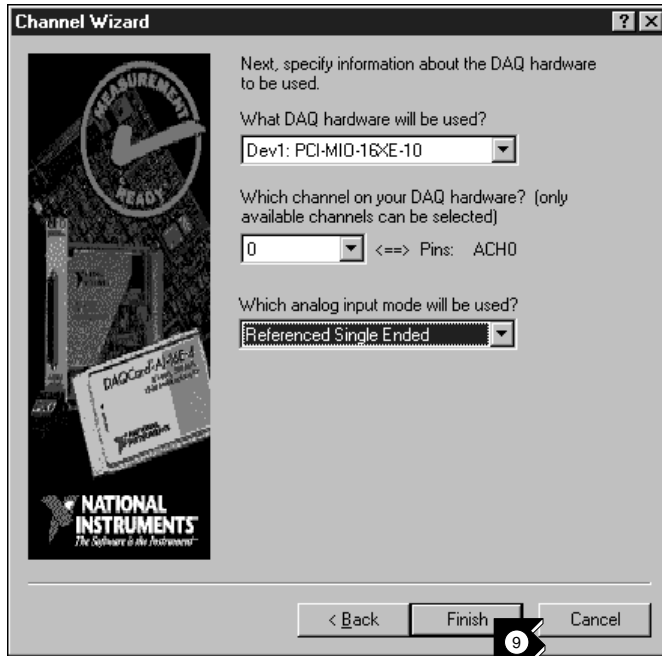

9. Select your data acquisition hardware settings. If you have multiple DAQ hardware devices installed, choose the device that will read this signal. Click **Finish** to configure your analog input channel.

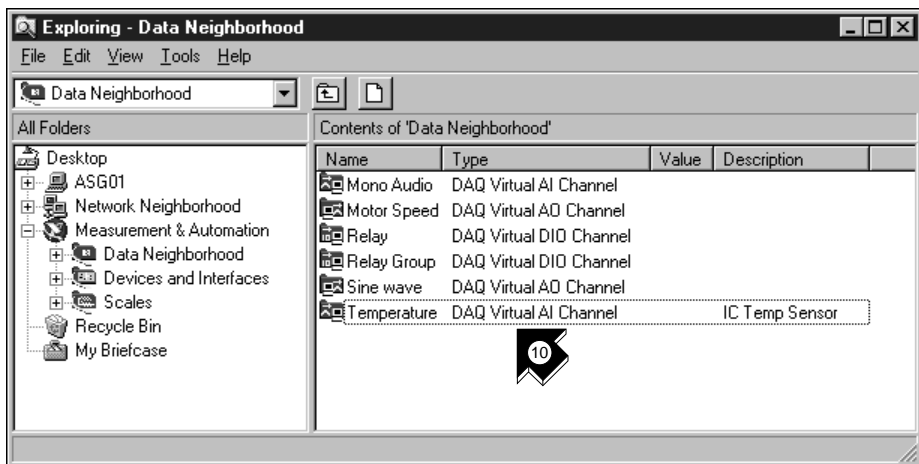

10. Notice that your new configuration appears. You have finished configuring an analog input channel named Temperature for your DAQ

hardware. This channel measures temperature from 0 to 100 degrees Fahrenheit, mapped from the 0 to 1 volt range of the sensor. Select **File>Close** to close the Measurement & Automation Explorer.

Generate a Solution from the Solutions Gallery

Once you have configured your channel, you can generate a solution from the Solutions Gallery.



You can complete this section in approximately 10 minutes.

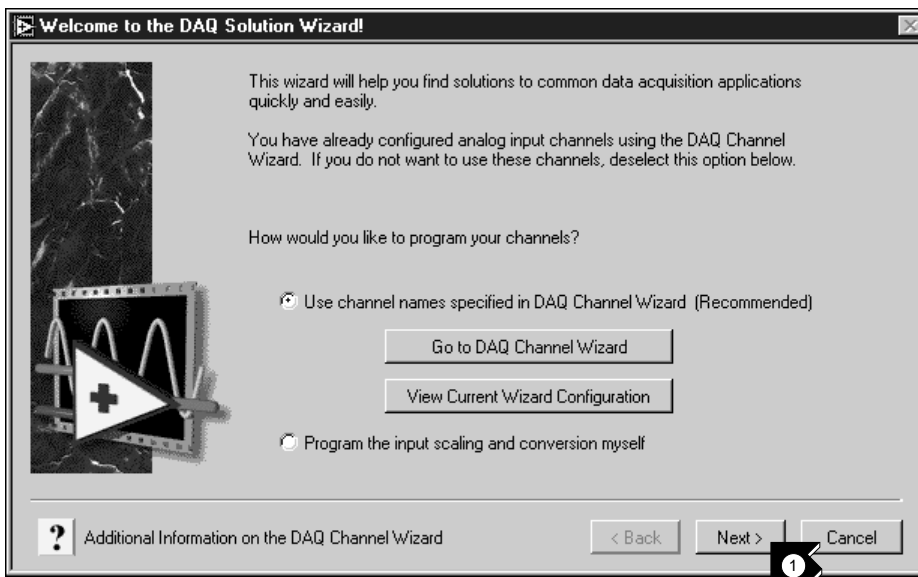

1. Click **Next>** when you return to the DAQ Solution Wizard.

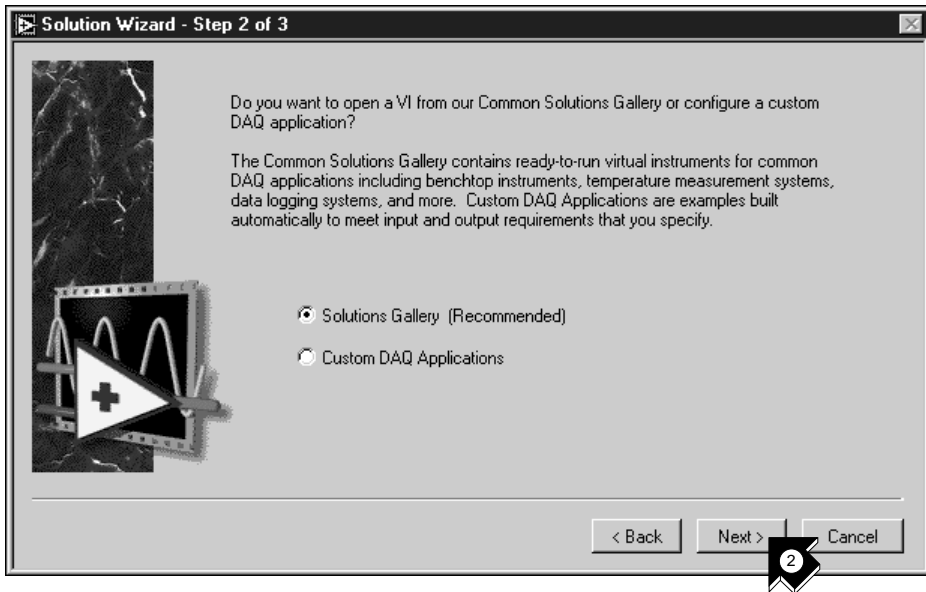

2. Click **Next>** in the DAQ Solution Wizard to open the Solutions Gallery.

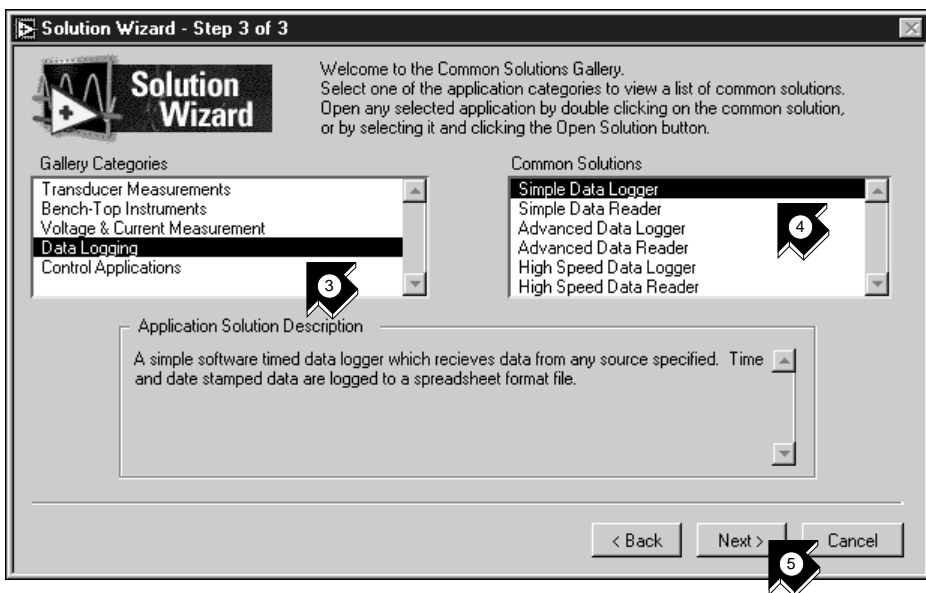

3. Choose a solution to generate for your analog input channel. For this example, select **Data Logging** in the Gallery Categories list.

4. Select **Simple Data Logger** in the Common Solutions list.
5. Click **Next>** to continue.

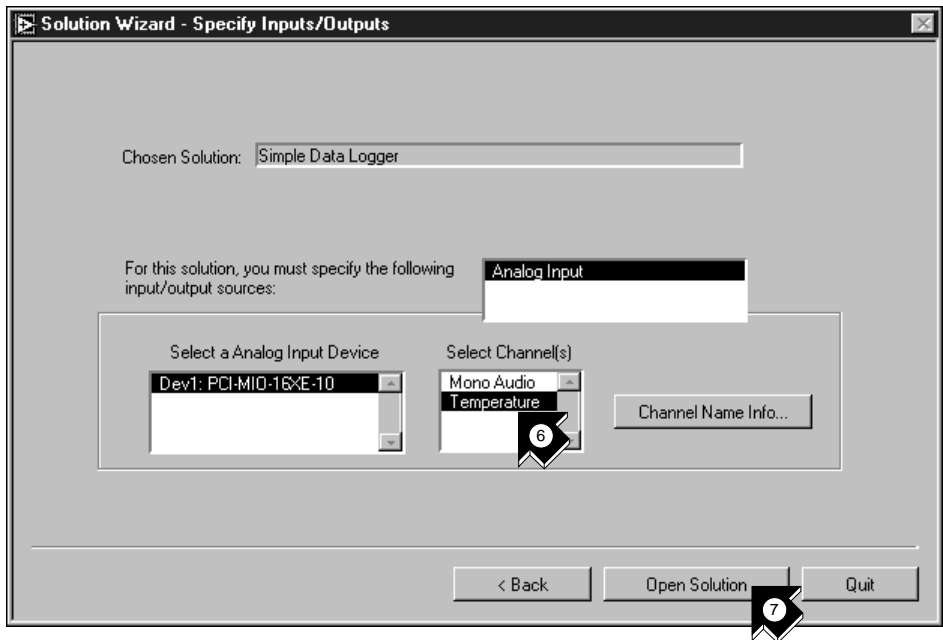

6. Select **Temperature** as the input channel to use for the solution.
7. Click **Open Solution** to generate the solution.

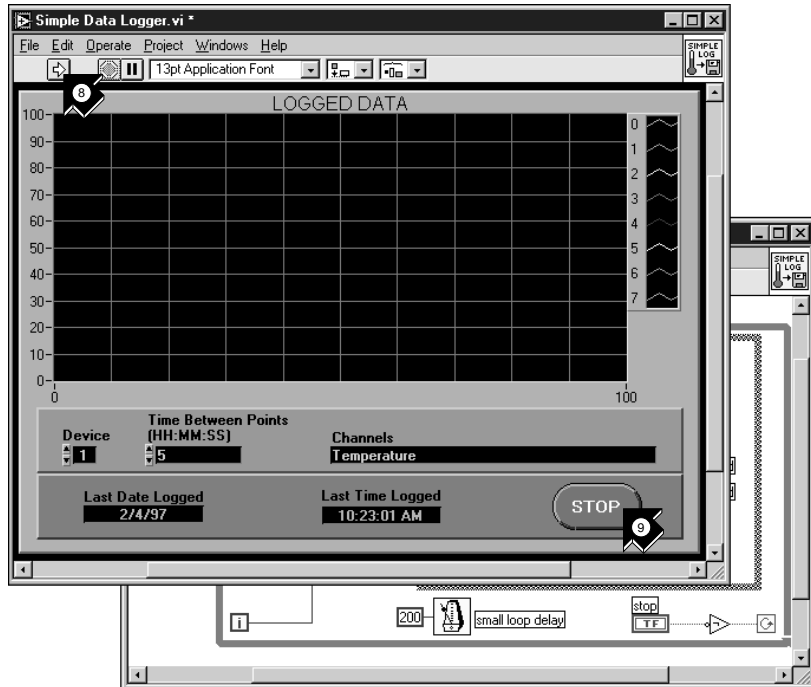

8. Click the **Run** button to take data from your configured analog input channel and log the data to a file. A file dialog box prompts you for a file name. Type `temp.txt` and click **Save**.
9. Click the **STOP** button at the lower-right corner of the front panel to stop the VI. Use any text editor to view `temp.txt`.



Tip You can customize the front panel and block diagram of the VI and save your customized solution to disk.

10. Close this VI and save any changes you want to keep.
11. Go to the DAQ Solution Wizard window and click **<Back** to browse other gallery categories and common solution VIs.
12. Click **Cancel** to exit.

Add Analog Input to Your VI

You have created a Random Number Example VI that generates random numbers and plots them to a strip chart. Now you can replace the random number generator with an analog input VI to acquire data from your DAQ board, plot it to a strip chart, analyze it, and write it to a file.



You can complete this activity in approximately 5 minutes.



Note *If you have not built the Random Number Example VI, you can find the solution VI in LabVIEW\vi.lib\tutorial.llb\Random Number Example Solution.vi.*

1. Open the Random Number Example VI from the LabVIEW\vi.lib\tutorial.llb directory.

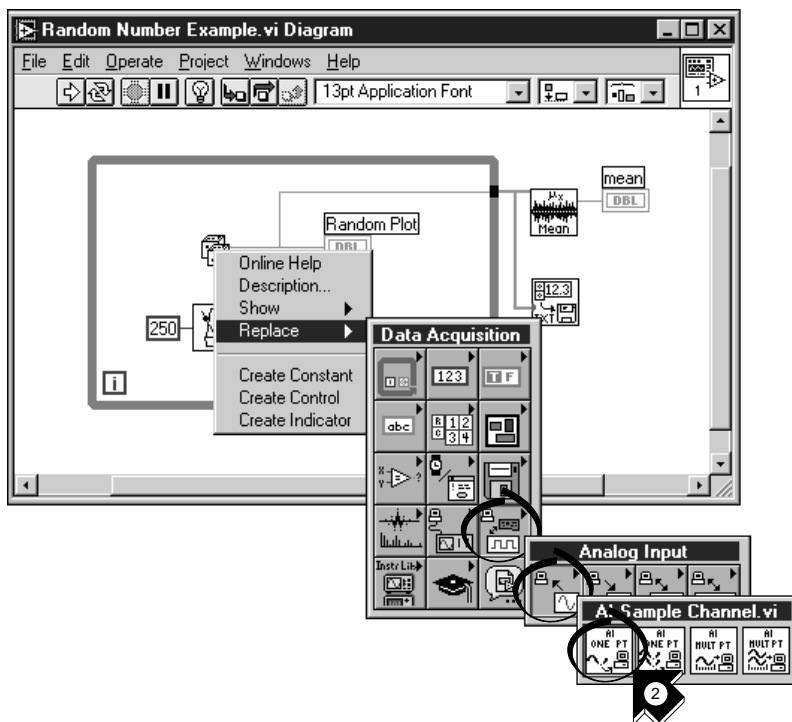

2. Go to the block diagram. From the pop-up menu on the Random Number function, choose **Replace»Data Acquisition»Analog Input»AI Sample Channel.vi**.



Tip Be sure to select **AI Sample Channel.vi** and **not** **AI Sample Channels.vi**.



Wiring tool

3. Select the **Wiring** tool from the Tools palette. The Wiring tool enables you to see the tip-strip labels for terminals on nodes in the block diagram.

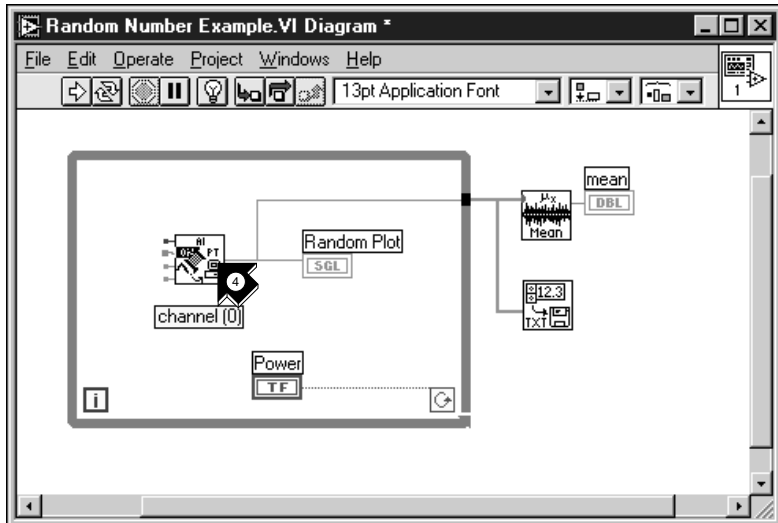

4. Move your pointer over the **channel (0)** terminal of the AI Sample Channel VI. A tip strip that labels the terminal appears.

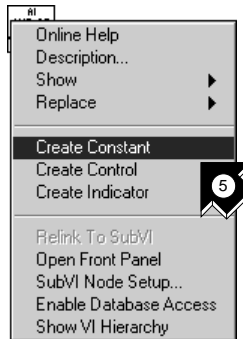

5. From the pop-up menu on the highlighted **channel (0)** terminal, choose **Create Constant**. To access the pop-up menu, right-click the terminal (on the Macintosh, command-click the terminal).

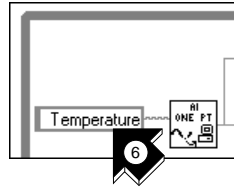

6. Type Temperature or the name of the channel you configured in the DAQ Channel Wizard.

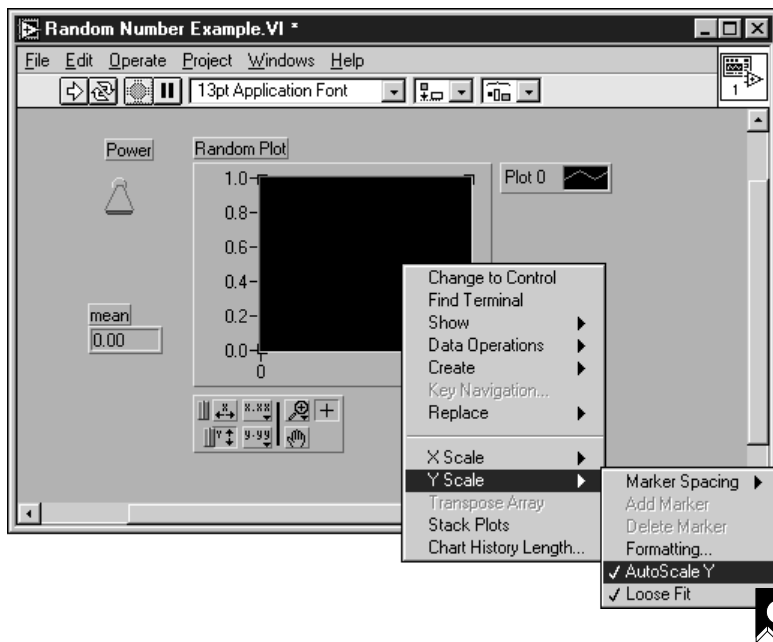

7. Go to the front panel. From the pop-up menu on the graph, choose **Y Scale»AutoScale Y**.

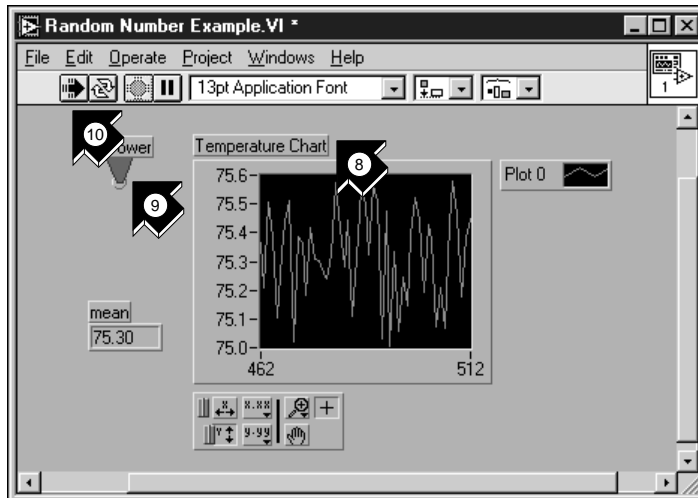

Labeling tool



Operating tool



Run

8. Using the *Labeling tool*, highlight the chart label and change the label to Temperature Chart.
9. Using the **Operating** tool, click the Power toggle switch to the TRUE position.
10. Click the **Run** button to see the data chart.
11. Click the Power toggle switch to stop the VI.
12. In the file dialog box, enter a name such as data.txt and click **Save**. This action saves your temperature data to a spreadsheet file.
13. Save this VI as Acquire Temperature.vi in the LabVIEW\vi.lib\tutorial.llb directory.

For multiple-point acquisition, waveform generation, digital I/O, or counter/timer applications, see the *LabVIEW Data Acquisition Basics Manual*.

(Windows) Use the **Search Examples** feature found in both the LabVIEW dialog box and the Help menu for examples and information. Search Examples guides you to DAQ examples for reference.

Use the **DAQ Solution Wizard** found in both the LabVIEW dialog box and the **File** menu to automatically generate DAQ applications that you can customize.

Instrumentation

This chapter teaches you how to use LabVIEW to acquire data from instruments controlled by GPIB, VXI, RS-232, and other hardware standards.

You will learn to do the following:

- Use the *Instrument Wizard* to communicate with your instrument.
- Run the Demo Scope VI if you do not have instrument I/O hardware installed.

Instrument I/O

LabVIEW communicates with most instruments through drivers, which are libraries of VIs that control programmable instruments. LabVIEW drivers simplify instrument control and reduce test development time by eliminating the need to learn the low-level programming protocol for each instrument.

Instruments obey a command set to respond to remote control and requests for data. When you use LabVIEW drivers, you run intuitive, high-level command VIs, such as the Read DC Voltage VI for a digital multimeter, or the Configure Time Axis VI for a digital oscilloscope. The called driver VI automatically sends the appropriate instrument-specific command strings to the instrument.

The foundation for LabVIEW drivers is the *VISA* (Virtual Instrument Software Architecture) VI library, a single interface library for controlling GPIB, VXI, RS-232, and other types of instruments. Drivers using VISA are scalable across instrument I/O interfaces.

Use the Instrument Wizard

In this activity, the Instrument Wizard guides you through communicating with your instrument. You then can open a Getting Started VI to learn how to program with an instrument driver.



You can complete this activity in approximately 5 minutes.



Tip If you do not have instrument I/O hardware installed, see the [Run the Demo Scope VI](#) section in this chapter.

1. To get started, close all windows and select **Solution Wizard** in the LabVIEW dialog box. When prompted, select **Instrument Wizard** and click **Launch Wizard...**, then click **Next>** to begin.



2. Select the types of devices you want the Solution Wizard to find, or select all types (GPIB, serial ports, VXI, and computer-based instruments) to find any listening instruments. Click **Next>** to continue.

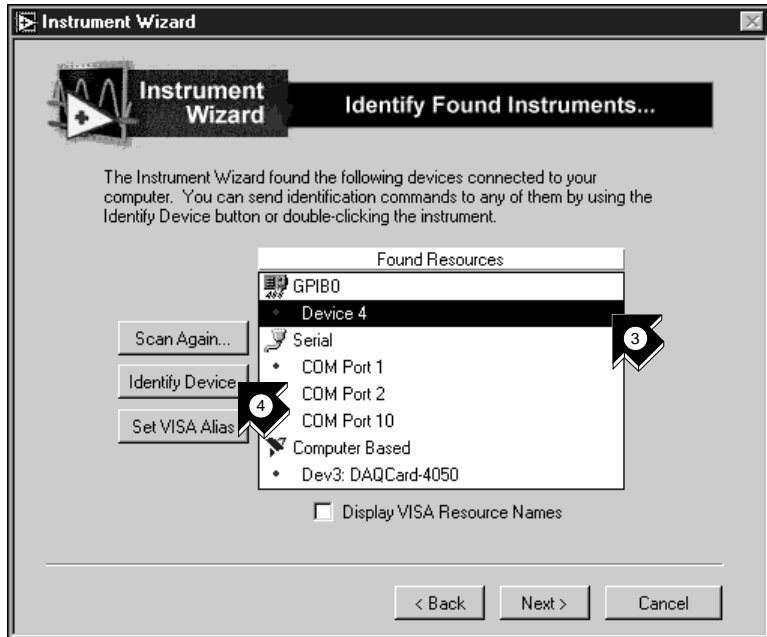

3. Select the device that appears in the list of found instruments. This example shows an HP 34401A digital multimeter on GPIB address 4.
4. Click **Identify Device** to communicate with the instrument.
5. By default, the string `*IDN?` appears in the command to send to this GPIB device. `*IDN?` is an [IEEE 488.2](#) standard identification request to the instrument. Click **OK** to send the string.
6. In this example the response string is from the HP 34401A digital multimeter. Click **Store** to save your configuration. The next time you launch the Instrument Wizard, it automatically will contain your stored instrument configuration.



7. If a LabVIEW driver for the identified instrument is available, you are prompted to install the driver if it is not installed already. Click **Install** to install a driver for your instrument. The wizard installs the correct driver in the `instr.lib` folder in the LabVIEW root directory. Click **Next>** to continue.



8. Notice that the driver for your instrument appears in the list of installed drivers. Select **Hewlett-Packard 34401A** or the name of your instrument and click **Open Example**. The Instrument Wizard opens an example program to communicate with your instrument.

**Note**

The Instrument Wizard lists ALL instruments you can control with the new drivers you have added.



Tip If you have a web browser installed, you can select **Help»Internet Links»Instrument Driver Network...** to link automatically to the **National Instruments Instrument Driver Network**. The **Instrument Driver Network** provides the complete library of available instrument drivers for **LabVIEW**.

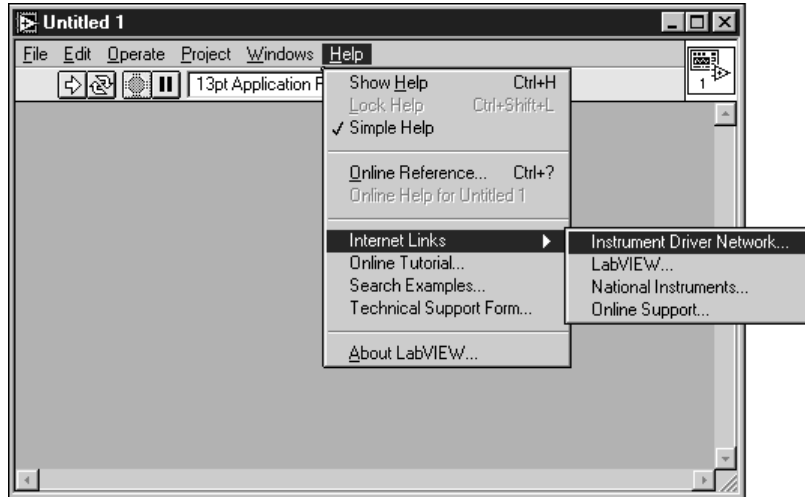

In this web page, you can search for your instrument among over **600** drivers available with free source code. You then can download the instrument driver you need and install it into the `instr.lib` folder in the **LabVIEW** root directory.

9. Click **Finish** to exit the Instrument Wizard. Now you can run your example driver VI.

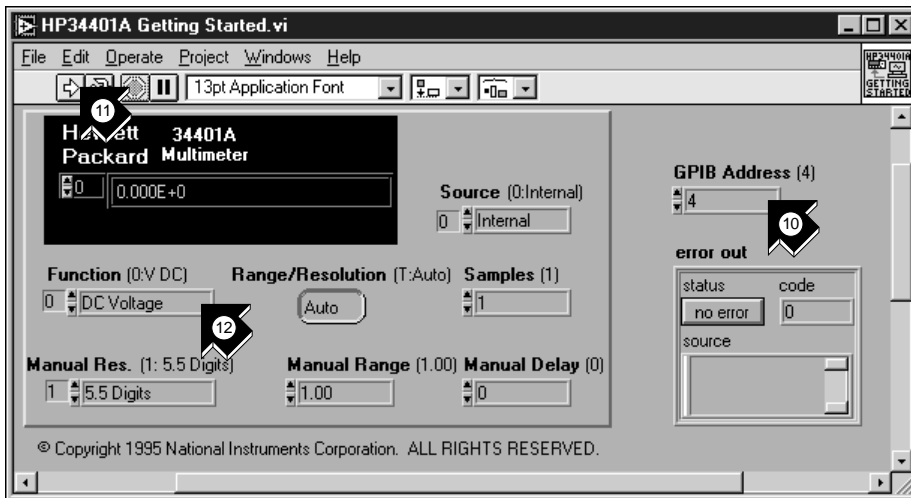

10. This VI controls the HP 34401A Digital Multimeter. On the front panel, verify the GPIB address of the HP 34401A Getting Started VI and change it if necessary. The default address is 4.



Run



Operating tool

11. Run the VI to measure DC voltage.

12. Using the **Operating** tool, change the **Function** input and run the VI again to see other measurements.

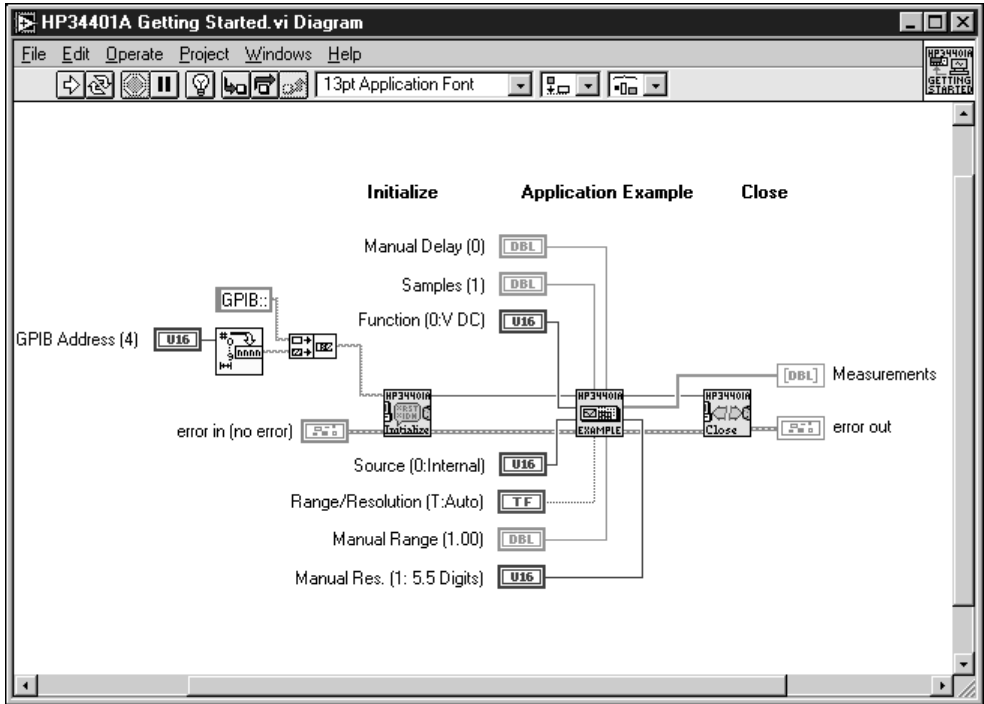

13. Examine the block diagram by selecting **Windows»Show Diagram**. The Getting Started VI is an example of a higher-level program that calls the instrument driver *subVIs* to control the instrument. The **HP 34401A Initialize** subVI is called first, followed by a subVI to control the instrument, and ending with the **HP 34401A Close** subVI.

To program your instrument, use the subVIs in **Functions»Instrument Drivers»Your Instrument**. The following graphic illustrates the HP34401A subpalette, which contains the Initialize VI, Application Example VIs, Close VI, and other VIs for the HP 34401A digital multimeter.

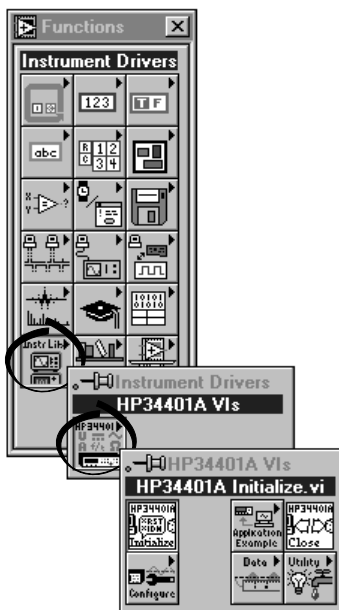

When you write your own program with an instrument driver, remember to call **Initialize** first, followed by the series of subVIs you want to use to control the instrument, and finally the **Close** subVI to close the instrument session. If you are not making repeated calls to the driver, you can use this high-level Getting Started VI in the block diagram of your VI, which initializes and closes the instrument for you.

Run the Demo Scope VI

If you do not have instrument I/O hardware installed, you can run the Demo Scope VI to see an example. The Demo Scope VI is the demonstration equivalent of a Getting Started VI for an actual instrument driver.



You can complete this activity in approximately 5 minutes.

1. Open the Demo Scope VI instrument driver in `LabVIEW\vi.lib\tutorial.llb`.

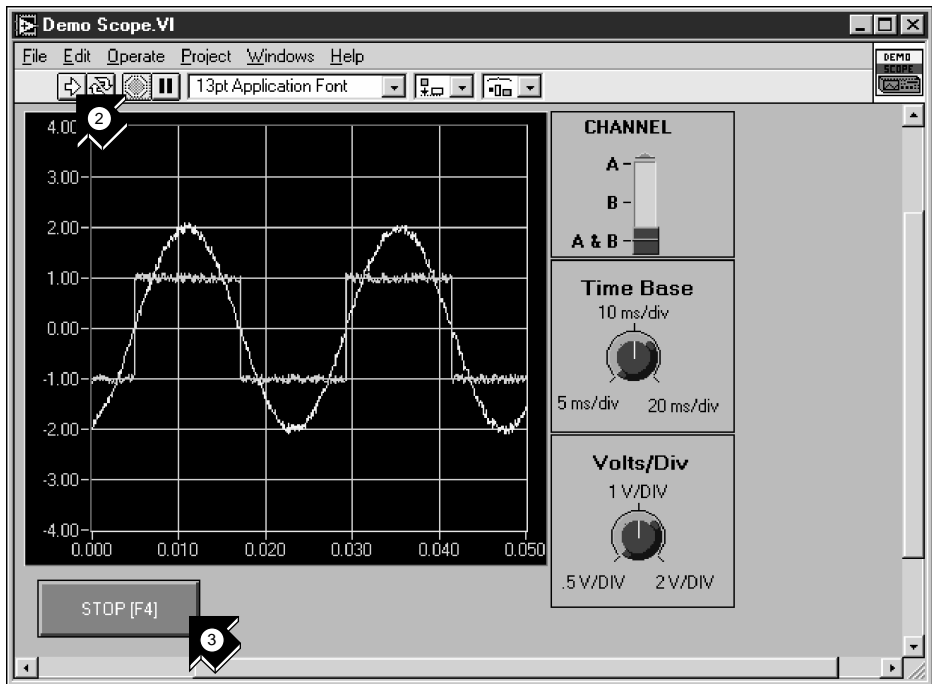

2. Run the program to acquire data from one or two channels on your oscilloscope. Change the time base and volts per division settings to see the effect.
3. Click the **STOP [F4]** button to stop the VI.

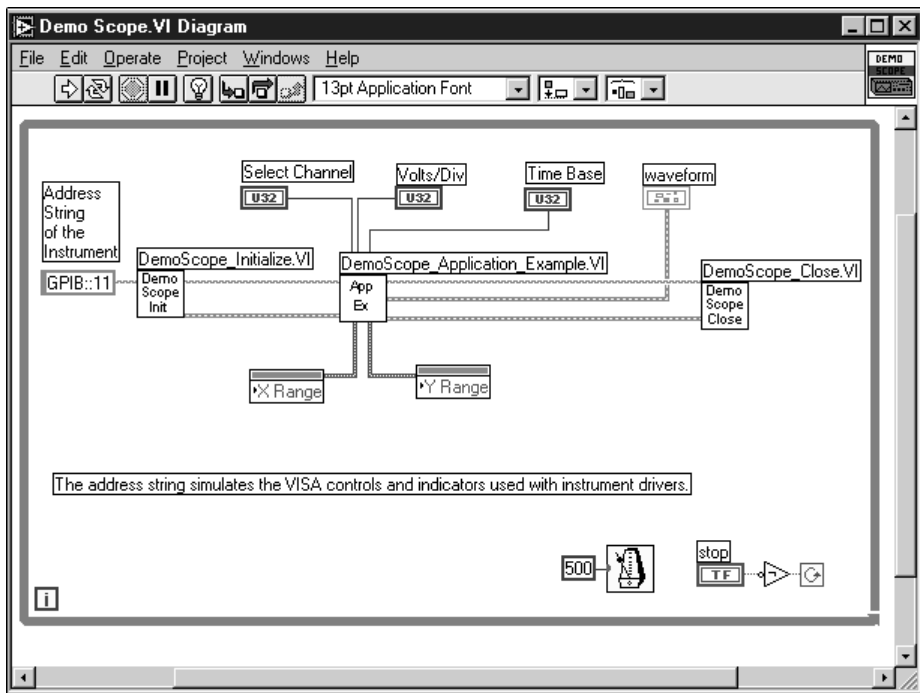

4. Go to the block diagram. Notice that Initialize is called first, followed by the commands to send to the instrument in the Application Example VI. The Close VI then closes communication with the instrument. When you program with LabVIEW drivers, follow this model of initializing the instrument, then calling the functions to control the instrument, and finally closing the instrument for communication.

Debugging

This chapter teaches you how to use some of the comprehensive debugging utilities in LabVIEW.

Use Execution Highlighting

Execution highlighting traces the data flow of a VI during execution.



You can complete this activity in approximately 5 minutes.



Operating tool

1. From the LabVIEW\vi.lib\tutorial.lib directory, open the Random Number Example VI you created earlier.
2. Using the **Operating** tool, click the Power toggle switch to the TRUE position.

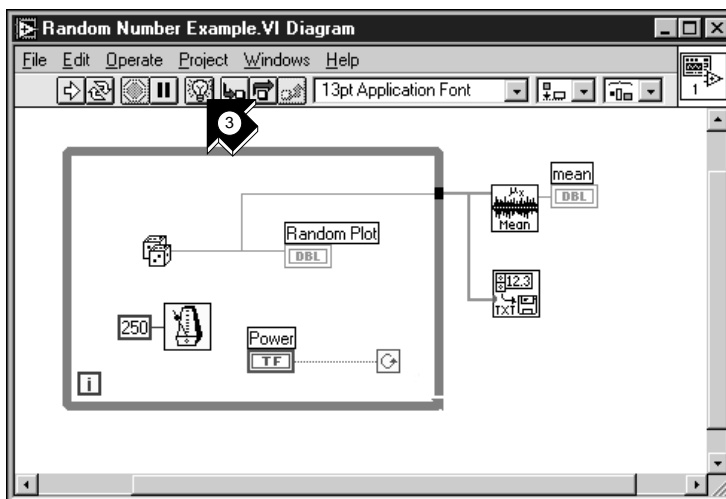

Highlight Execution

3. Go to the block diagram and click the **Highlight Execution** button on the toolbar.

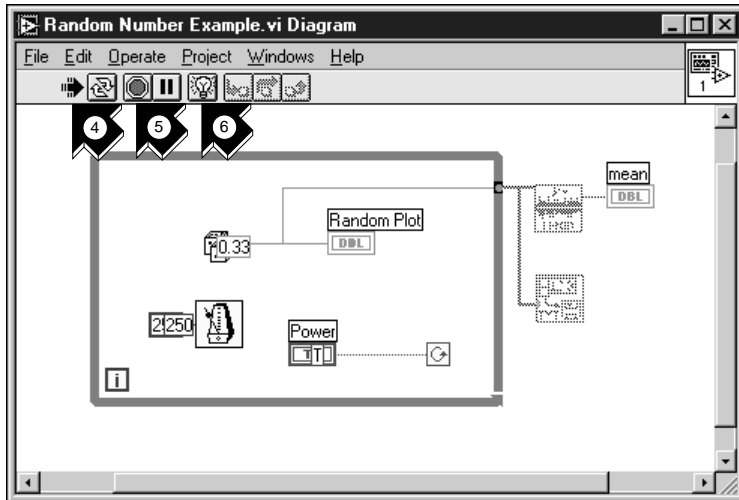

Run



Abort



Highlight Execution

4. Run the VI from the block diagram window. The program executes in slow motion with moving bubbles to highlight the flow of execution. It also displays data as it becomes available in the VI.
5. Stop the VI by clicking the **Abort** button.
6. Turn off execution highlighting by clicking the **Highlight Execution** button again.

Single-Step with Probes

You can set breakpoints in a VI and single-step into, out of, and over sections of the block diagram. You also can insert *probes* to examine data values in detail during program execution. This example shows how to single-step through a VI and insert probes to monitor your data while the VI runs.



You can complete this activity in approximately 5 minutes.

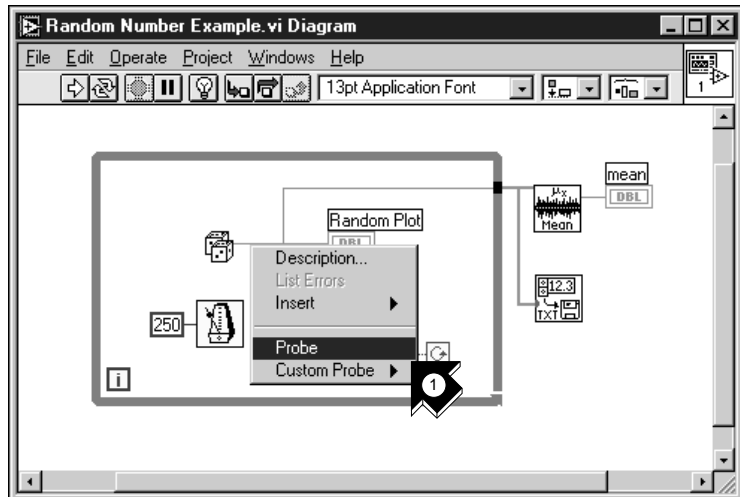

1. From the pop-up menu on the output wire of the Random Number function, choose **Probe**. A small **number: ...** window displays the value of the data at that point.



Tip Make sure the **Power toggle switch** is in the **TRUE** position in the front panel.

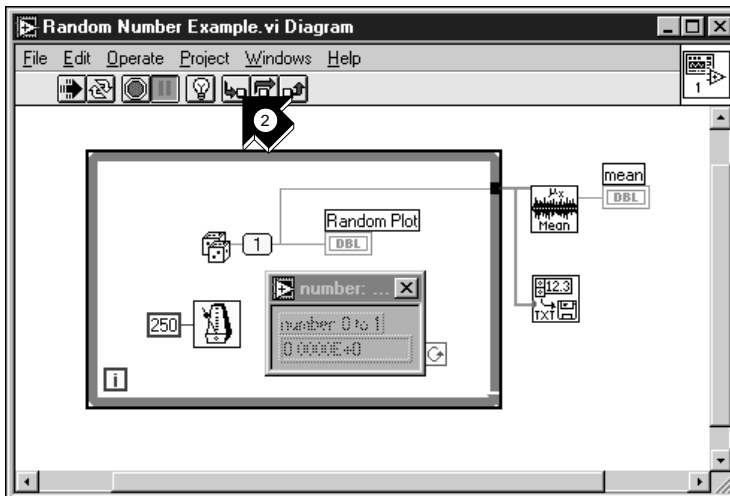

Step Into

2. Click the **Step Into** button on the toolbar. The While Loop now flashes, indicating that the program is executing in single-step mode.
3. Click the **Step Into** button again. The Random Number function now flashes.

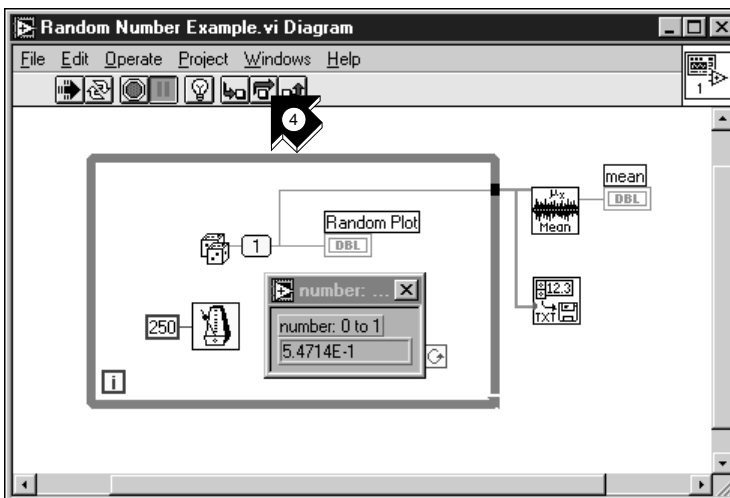

Step Over

4. Click the **Step Over** button to step over the Random Number function. The random number function executes, so the output now appears in the probe.

- Using **Step Into** and **Step Over** buttons, single step a few more times through the loop to view each random number as it is generated in the VI.

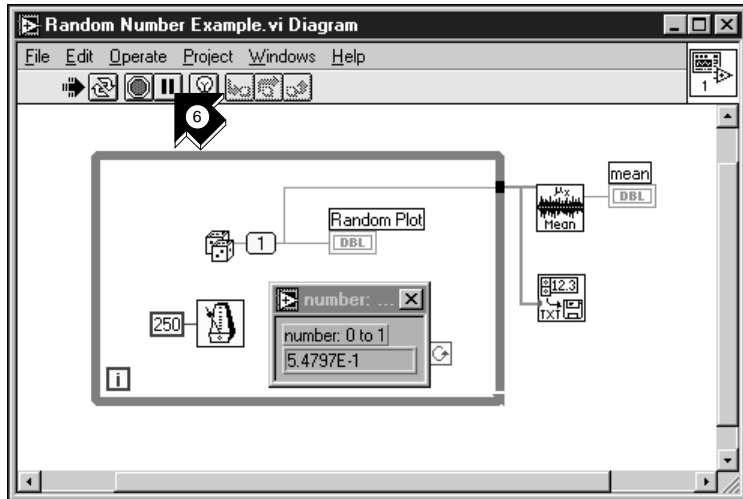

Pause

- To run your VI in normal mode, deselect the **Pause** button.
- Go to the front panel and click the Power toggle switch to the FALSE position to stop the VI. Save the collected data to `data.txt`.

Where to Go from Here

This chapter teaches you how to use the Online Help and Show Help features in LabVIEW. It also outlines National Instruments' commitment to your success and the additional resources available to you. To learn more about LabVIEW programming techniques, consult the *LabVIEW User Manual*, the *G Programming Reference Manual*, or the *LabVIEW Online Reference*, which you access by choosing **Help»Online Reference...**



Note

The LabVIEW documentation set is available in Portable Document Format (PDF) on the LabVIEW CD in the manuals directory. You can copy this directory or selected PDF files to the LabVIEW\manuals directory on your hard drive. You must have Adobe Acrobat Reader 3.0 or later installed to view these files.

Online Help

All built-in LabVIEW VIs have a complete online reference. When you find an unfamiliar VI, place it on your block diagram and choose **Online Help** from the pop-up menu on the VI. Online Help gives you a complete description of the VI functionality and parameters.

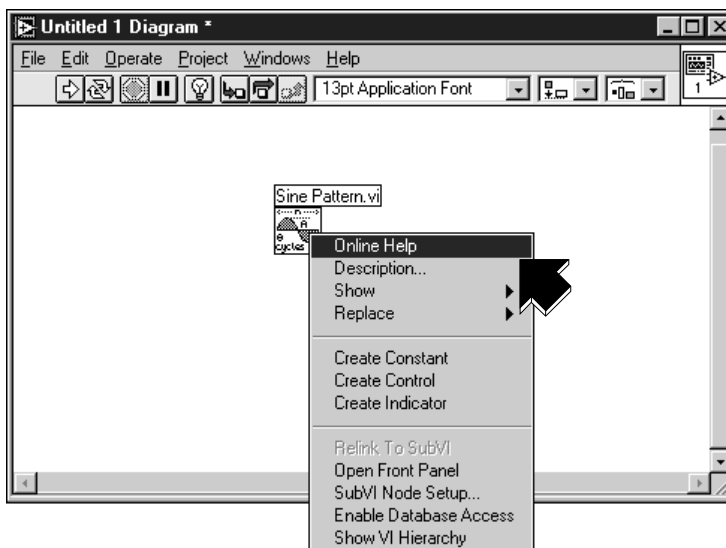

Show Help

If you need a quick reference to remind you about VI functionality or input and output parameters, select **Help»Show Help**.

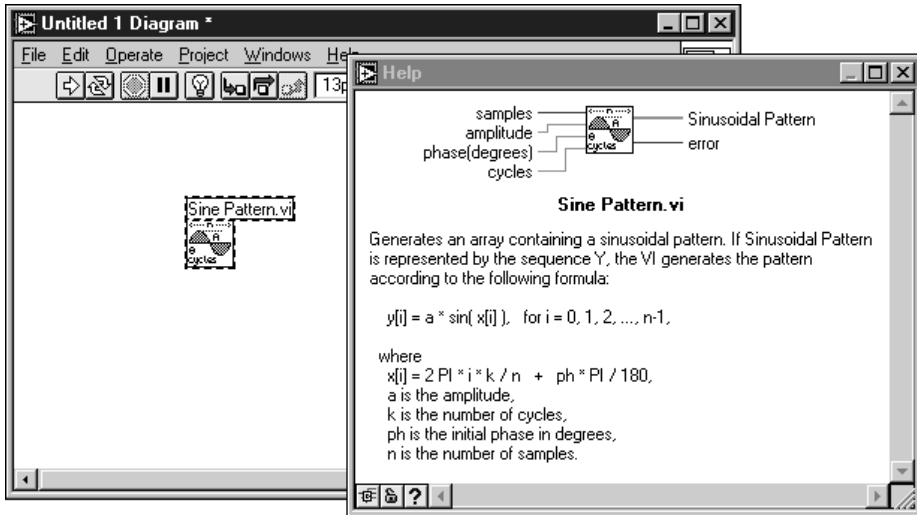

The Help window is context-sensitive, so when you need information about a VI, place your pointer over the VI icon. Click the lock button at the bottom of the Help window to lock the current contents of the Help window.

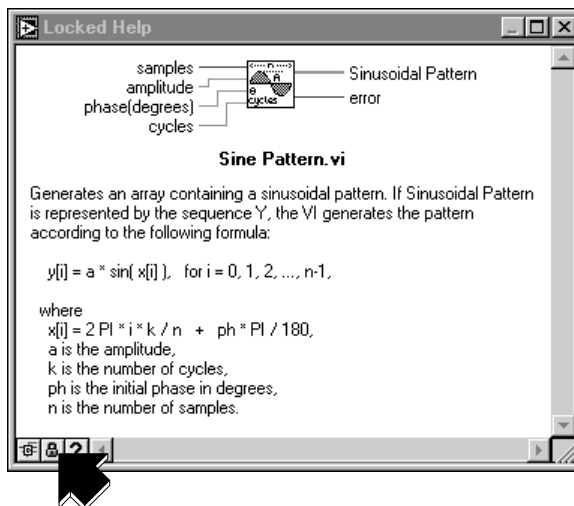

National Instruments' Commitment to You

LabVIEW represents a long-standing commitment by National Instruments to provide tools that simplify the development of instrumentation systems. When you choose LabVIEW as your development environment, you join thousands of scientists and engineers who are taking advantage of the power of graphical programming.

Customer Education

For additional training, National Instruments offers interactive CDs, videos, books, and hands-on LabVIEW courses to help you master LabVIEW quickly and develop successful applications.

National Instruments' comprehensive LabVIEW training courses can help you learn to build applications quickly. In these courses, our applications engineers give you concentrated instruction as well as design tips for the LabVIEW development environment. These courses take place monthly at our corporate headquarters in Austin, Texas, and also at our branches around the world. In addition, we offer two-day courses on GPIB, DAQ, VXI, and other topics to help you develop your entire system.

Alliance Program

The Alliance Program is a network of third-party developers and consultants who are experts in LabVIEW and other National Instruments products. The National Instruments *Alliance Solutions* directory lists additional libraries and utilities developed by our Alliance members to help you use LabVIEW. In addition, the *Alliance Solutions* directory lists expert LabVIEW consultants who can help you develop custom applications.

Technical Support

National Instruments offers you complete technical support. You can use our Internet sites (Web and FTP), BBS, or fax-on-demand systems to download valuable information and product examples, question-and-answer documents, and technical development tips. A technical forum for LabVIEW is available on the Internet where you can discuss issues with other LabVIEW users. In addition, National Instruments has experienced Applications Engineers located throughout the world to assist you.

System Requirements

This appendix describes the required system configurations for running LabVIEW on Windows, Macintosh, and UNIX platforms.

**Note**

On Windows, you need approximately 60 MB of disk storage space for a minimal installation of LabVIEW and 85 MB for a full installation. On Macintosh, you need approximately 100 MB of disk storage space for a minimal installation of LabVIEW and 120 MB for a full installation. On UNIX, you need a minimum of 65 MB of disk storage space for the entire LabVIEW package.

Windows

LabVIEW has the following system configuration requirements for Windows platforms:

- **Windows 98/95**—LabVIEW runs on any system that supports Windows 98/95. National Instruments recommends 32 MB of RAM and a Pentium processor for effective operation.
- **Windows NT**—LabVIEW requires Windows NT 4.0 Service Pack 3 or later. National Instruments recommends 32 MB of RAM and a Pentium processor for effective operation. LabVIEW for Windows NT only runs on Windows NT 80x86 computers. DEC Alpha, MIPS, and PowerPC 80x86 emulators must emulate 80386 instructions to run LabVIEW.

Macintosh

LabVIEW requires System 7 or 8, with a minimum of 24 MB of RAM, but National Instruments recommends at least 32 MB of RAM for effective operation on the Power Macintosh.

UNIX

LabVIEW has the following system configuration requirements for UNIX platforms:

- LabVIEW requires an X Window System server, such as OpenWindows 3.x, HP-VUE, or X11R6.
- LabVIEW for Sun runs on SPARCstations with Solaris 2.4 or later.
- LabVIEW for HP-UX runs on Hewlett-Packard Model 9000 Series 700 computers under HP-UX 10.20 or later.
- LabVIEW for Concurrent PowerMAX runs on PowerPC-based systems running PowerMAX version 4.2 or later.
- LabVIEW for Linux runs on Linux for Intel x86 processors running version 2.0.x or later.

Glossary

B

block diagram A pictorial description or representation of a program or algorithm. In LabVIEW, the block diagram, which consists of executable icons called nodes and wires that carry data between the nodes, is the source code for the VI. The block diagram resides in the Diagram window of the VI.

C

conditional terminal The terminal of a While Loop that contains a Boolean value that determines whether the VI performs another iteration.

control Front panel object for entering data to a VI interactively or to a subVI programmatically.

Controls palette Palette containing front panel controls and indicators.

D

DAQ Channel Wizard Utility that guides you through naming and configuring your DAQ analog and digital channels.

DAQ Solution Wizard Utility that guides you through specifying your DAQ application, from which it provides a custom DAQ solution.

data flow Programming system consisting of executable nodes in which nodes execute only when they have received all the required input data and produce output automatically when they have executed. LabVIEW is a dataflow system.

E

- Enable Indexing** Option that allows you to build a set of data to be released at the termination of a While Loop. With indexing disabled, a While Loop releases only the final data point generated within the loop.
- execution highlighting** Feature that animates VI execution to illustrate the data flow in a VI.

F

- front panel** The interactive user interface of a VI. Modeled from the front panel of physical instruments, it is composed of switches, slides, meters, graphs, charts, gauges, LEDs, and other controls and indicators.
- function** Built-in execution element, comparable to an operator, function, or statement in a conventional language.
- Functions palette** Palette containing block diagram structures, constants, communication features, and VIs.

G

- G** The graphical programming language used to develop LabVIEW applications.
- GPIB** General Purpose Interface Bus is the common name for the communications interface system defined in ANSI/IEEE Standard 488.1-1987 and ANSI/IEEE Standard 488.2-1987. Hewlett-Packard, the inventor of the bus, calls it the HP-IB.

I

- IEEE 488.2** Institute of Electrical and Electronic Engineers Standard 488.2-1987, which defines the GPIB.
- indicator** Front panel object that displays output.
- Instrument Wizard** Utility that guides you through communicating with your instrument.

L

Labeling tool	Tool used to create labels and enter text into windows.
LabVIEW	Laboratory Virtual Instrument Engineering Workbench.

M

MB	Megabytes.
----	------------

N

node	Execution element of a block diagram, such as a function, structure, or subVI. <i>See also</i> data flow, wire.
------	---

O

Operating tool	Tool used to enter data into controls as well as operate them.
----------------	--

P

palette	A display of icons that represent possible options. <i>See also</i> Controls palette, Functions palette, subpalette, Tools palette.
Positioning tool	Tool used to move, select, and resize objects.
probe	Debugging feature for checking intermediate values in a VI.
PXI	PCI eXtensions for Instrumentation.

R

RS-232	Recommended Standard 232, a serial interface bus standard.
RS-485	Recommended Standard 485, a serial interface bus standard.

S

Solutions Gallery	Option within the DAQ Solution Wizard in which you can select from numerous categories of common DAQ applications.
structure	Program control element, such as a While Loop.
subpalette	A palette contained in an icon of another palette.
subVI	VI used in the block diagram of another VI; comparable to a subroutine.

T

terminal	Object or region on a node through which data passes.
tip strip	A text banner that displays the name of an object, control, or terminal.
Tools palette	Palette containing the tools you can use to edit and debug front panel and block diagram objects.
tunnel	Data entry or exit terminal on a structure.

V

VI	<i>See</i> virtual instrument.
virtual instrument	A program in the graphical programming language G that models the appearance and function of a physical instrument.
VISA	Virtual Instrument Software Architecture. A single interface library for controlling GPIB, VXI, RS-232, and other types of instruments.
VXI	VME eXtensions for Instrumentation (bus).

W

waveform chart	An indicator that plots data points at a certain rate.
While Loop	Loop structure that repeats a section of code until a condition is met. Comparable to a Do loop or a Repeat-Until loop in conventional programming languages.

wire	Data path between nodes. <i>See also</i> data flow.
wire branch	A section of wire that contains all the wire segments from one junction to another, from a terminal to the next junction, or from one terminal to another if no junctions exist in between.
wire junction	The point where three or more wire segments join.
wire segment	A single, horizontal or vertical piece of wire.
Wiring tool	Tool used to define data paths between terminals. Resembles a spool of wire.